

2 HTS-Microplates

☞ Technical Information	2 2
☞ 96 Well Microplates	2 6
96 Well Polystyrene Microplates	2 6
96 Well Half Area Polystyrene Microplates	2 9
96 Well Polypropylene Microplates	2 10
☞ 384 Well Microplates	2 12
384 Well Polystyrene Microplates	2 12
384 Well Polypropylene Microplates	2 15
384 Well Small Volume™ LoBase and HiBase Microplates	2 16
384 Deep Well Small Volume™ Polypropylene Microplate	2 18
☞ 1536 Well Microplates	2 19
1536 Well Polystyrene Microplates	2 19
1536 Well HiBase and LoBase Microplates	2 19
☞ Standard Storage Plates	2 22
96 Well MASTERBLOCK®	2 22
96 Well Storage Box	2 25
384 Deep Well MASTERBLOCK®	2 26
1536 Deep Well Polypropylene Microplate	2 27
☞ Compound Storage Microplates	2 28
384 Well Polypropylene Microplate	2 28
384 Well Cycloolefin Microplate	2 28
1536 Well Cycloolefin Microplates	2 28
☞ Non-binding Microplates	2 30
96 Well Non-binding Microplates	2 31
384 Well Non-binding Microplates	2 32
1536 Well Non-binding Microplates	2 32
☞ Streptavidin-coated Microplates	2 33
☞ SensoPlate™	2 34
24 Well SensoPlate™	2 35
96 Well SensoPlate™	2 35
384 Well SensoPlate™	2 35
384 Well SensoPlate™ Plus	2 35
1536 Well SensoPlate™	2 35
1536 Well SensoPlate™ Plus	2 35
☞ UV-Star® Microplates	2 36
96 Well UV-Star® Microplates	2 37
384 Well UV-Star® Microplate	2 37





HTS-Microplates

1. Standard Microplate Footprint

The manufacture of user-friendly products is one of our most important goals. All microplates manufactured by Greiner Bio-One have a uniform footprint (Fig. 1) which is conform to the recommendation of the American National Standards Institute (ANSI 1-2004). For detailed information about the external dimensions of our microplates and the conformity with ANSI standards, please visit our website: www.gbo.com/bioscience/technical_information - or ask for data sheets and customer drawings. For further information about ANSI standards, please visit the society's website: www.slas.org.

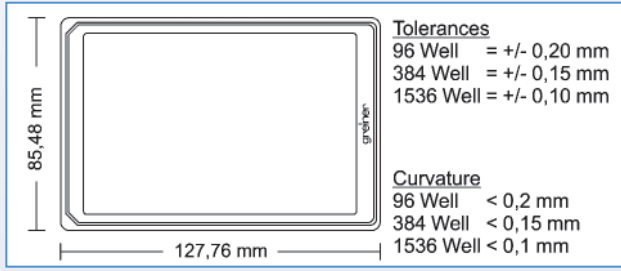

Figure 1: Footprint and tolerances of standard microplates

2. Material

Polypropylene (PP) and **polystyrene (PS)** are the standard materials used to manufacture the majority of microplates. Polystyrene is a highly clear polymer with excellent optical properties which makes it ideal for precise optical measurements. Polystyrene is also characterised by its ability to bind biomolecules, such as proteins, and it is therefore often used for manufacturing immunological products. Polystyrene is suitable for work with cell cultures.

Polypropylene is characterised by its excellent chemical and thermal stability. It is the ideal polymer for storage vessels or microplates. Polar molecules, such as proteins or DNA, are binding less to polypropylene than to polystyrene.

In addition to polystyrene and polypropylene microplates, Greiner Bio-One manufactures microplates with special requirement profiles, such as the UV-Star® microplates made from different **polyolefins**. These polyolefins are characterised by their low level of autofluorescence (Fig. 2), exceptionally high clarity, especially in the UV range (Fig. 3), and greater chemical stability when compared with polystyrene. A listing of chemical compatibilities of the main polymers used (→ Technical Appendix) can be found in Greiner Bio-One forum No. 3 or on our website www.gbo.com/bioscience.

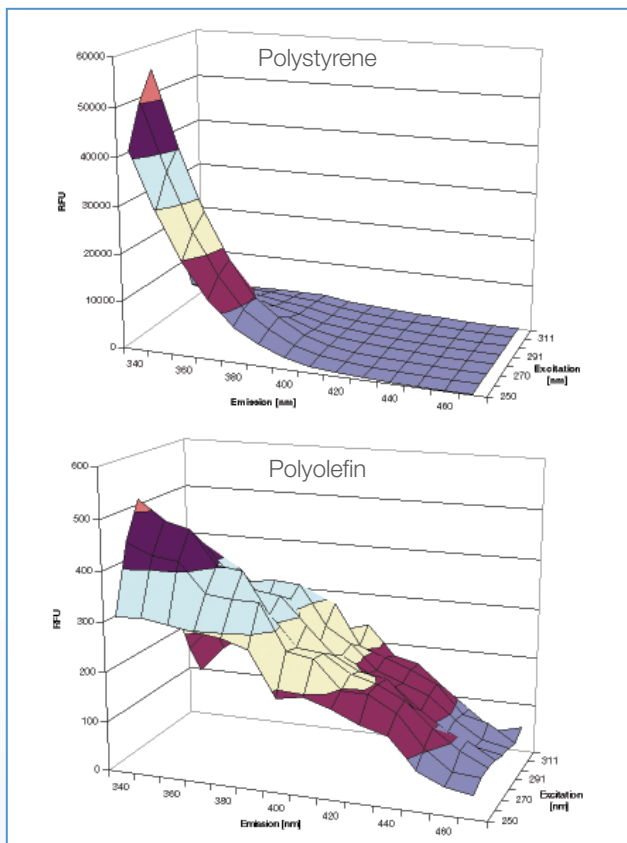

Figure 2: More than 100 x lower autofluorescence of the UV-Star® polyolefin compared with polystyrene

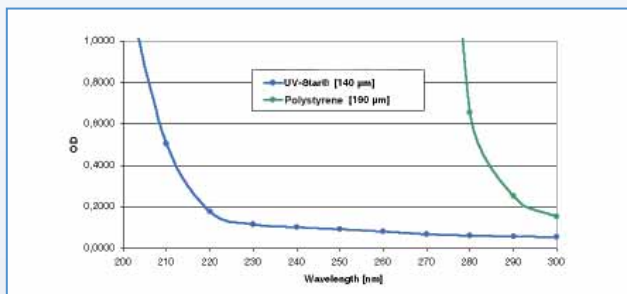

Figure 3: Light transmission in the UV range. Comparison of polystyrene/polyolefins

3. µClear® and UV-Star®

The move from isotopic to non-isotopic assays (fluorescence/luminescence), and new applications in high-throughput and high-content screening increased the demand for clear bottom plates, microplates with pigmented walls and thin film bottoms.

Up to now, clear bottom microplates have mostly been manufactured using a two-component injection moulding procedure by sticking or welding the components together. The development of a completely new and patented processing technique has made it possible for us to produce microplates with ultra-thin films, without the use of adhesives or solvents – the µClear® and UV-Star® products. This special method eradicates the risk of leaking wells (Fig. 4).

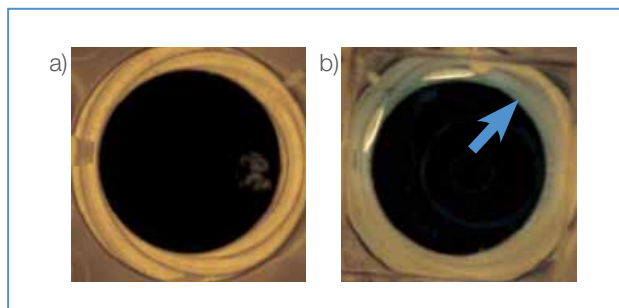

Figure 4: Wells filled with methylene blue after threefold freezing and thawing: a) single well of a Greiner Bio-One UV-Star® microplate b) single well of a 96 well UV-transparent microplate of a competitor

The choice of suitable films is the decisive factor, and this will influence the quality of a clear bottom microplate. Strict controls before and during production guarantee a constant quality. Polarised light is either not depolarised (UV-Star®) or is only depolarised to a slight degree (µClear®) and the autofluorescence of the microplates is minimised (Fig. 5).

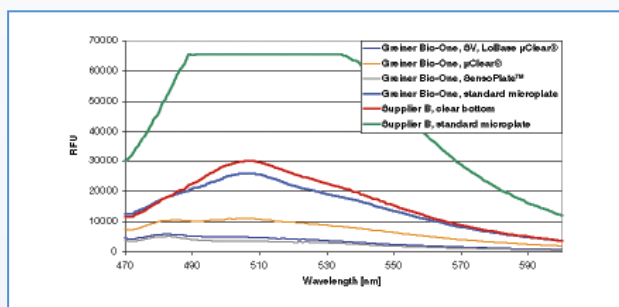

Figure 5: Autofluorescence of different 384 well microplates at an excitation wavelength of 485 nm

The 96 well µClear® microplates and 384 well µClear® microplates have a film thickness of 190 µm +/- 20 µm. In the 1536 well microplates with a transparent bottom (µClear®) the film thickness is 75 µm +/- 10 µm. UV-Star® microplates generally have a film thickness of 135 µm +/- 10 µm.

4. Black or White?

White microplates are usually used for luminescence measurements (e.g. Luciferase Reporter Assays) and black microplates for fluorescence measurements (e.g. Green Fluorescence Protein). The critical properties in these methods, such as background, autofluorescence or crosstalk are considerably improved by the use of black or white pigmented microplates. The optical and physical properties of the Greiner Bio-One microplates were investigated in our laboratory. Higher pigment concentrations produced a much lower autofluorescence of the microplates. At shorter wavelengths, this influence is more pronounced than at the normal fluorescein wavelength combination of 485/520 nm (Fig. 6, 7). When comparing different white fractions, the same results were obtained for phosphorescence.

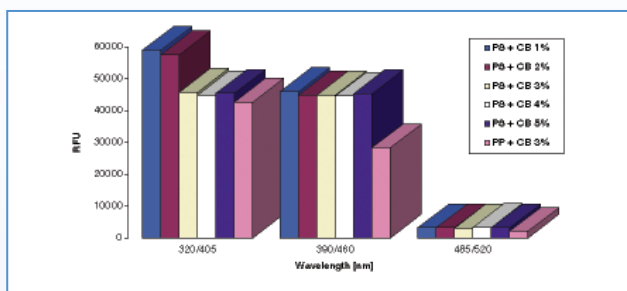

Figure 6: Influence of the black pigment fraction and the wavelength used on the autofluorescence of 96 well microplates

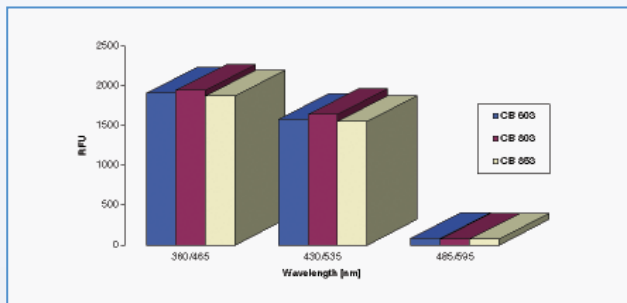

Figure 7: Influence of different black pigments on the autofluorescence of 96 well microplates

5. MICROLON®, FLUOTRAC™, LUMITRAC™

MICROLON®, FLUOTRAC™, and LUMITRAC™ stand for the quality of our immunology products. MICROLON® are clear microplates for transmission measurements. FLUOTRAC™ are black microplates for fluorescence measurements. LUMITRAC™ are white microplates for luminescence measurements.

MICROLON® 600, FLUOTRAC™ 600 and LUMITRAC™ 600 are high binding polystyrene surfaces that have been specifically treated to provide an increased protein binding. MICROLON® 200, FLUOTRAC™ 200 and LUMITRAC™ 200 are medium binding (med. binding) polystyrene surfaces. The polystyrene surface of a medium binding microplate is more hydrophobic than the surface of a high binding microplate, and therefore tends to be more suitable for non-polar proteins and peptides. The consistency and reproducibility of our immunology products is constantly evaluated using an ELISA (Fig. 8).

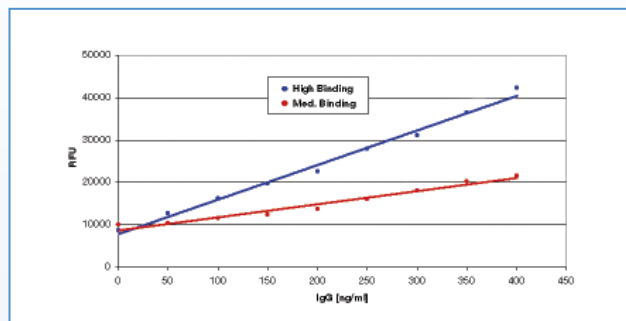

Figure 8: Fluorescence ELISA

In general, high binding microplates are recommended for ELISAs. The protein binding to the polystyrene surface can vary greatly and depends, among other things, on properties such as charge or size. When developing a new assay, it is therefore advisable to compare high binding and medium binding microplates in advance (→ see chapter 3).

We will be glad to supply samples for evaluation.

6. Non-binding Surfaces

Non-binding surfaces from Greiner Bio-One are characterised by their low binding capacity for biomolecules such as DNA, RNA, peptides and proteins. The repellent property of the non-binding surfaces for biomolecules can be advantageous in biochemical assays by increasing the sensitivity, reducing the background and improving the signal-to-noise ratio.

Achieved through a chemical modification of the resin rather than a resin mixture with potential to leach, the non-binding surface from Greiner Bio-One is stable under common assay conditions and does not degrade during short-term storage. The complete portfolio of non-binding microplates can be found on p. 2 | 30 ff.

7. Cell Culture Products / CELLSTAR® / TC

The polystyrene surface of an untreated microplate is hydrophobic and does not offer adherent cell lines a surface conducive to growth. Cell culture microplates from the CELLSTAR® range are specifically treated. This treatment leads to polar groups, such as carboxy and hydroxy groups, being incorporated into the plastic surface, making it hydrophilic. This significantly improves the adhesion of cells and the binding of proteins to the plastic surface. CELLSTAR® products are consistently evaluated using different cell lines.
Cell culture treated microplates → chapter 1.

8. Lids for Microplates (→ chapter 12)

Four different polystyrene lid designs are available:

- ☞ High profile lids
- ☞ High profile lids with condensation rings
- ☞ Low profile lids
- ☞ Ultra low profile lids

Lids are available in two options, sterile and non-sterile. If microplates are supplied with lids, as in the case of CELLSTAR® products, the 96 well microplates always include lids with a high profile (“lid, high profile”) and the 384 well microplates always include plate lids with a low profile (“lid, low profile”). In addition all products are also available without lids, which means that the type of lid can be selected as required.

Greiner Bio-One microplates:

- Are manufactured under DIN ISO 9001 guidelines
- Can be traced all the way back to production through a defined LOT number system
- Footprint compatible with automated systems
- Are free of detectable endotoxins (0.03 EU/ml) and regularly tested using an FDA-approved kinetic turbidimetric LAL-test (Limulus Amoebocyte Assay)
- Are analysed for detectable DNase, RNase and human DNA (→ Quality p. V)
- Are manufactured without the use of silicon-based mould release
- Are free of biozides and antistatics
- Are manufactured out of raw materials tested for leachables
- Barcode-labelling on request (→ p. 14 | 4)



An overview of all 96 well, 384 well and 1536 well microplates listed in this catalogue can be found in the Technical Appendix → p. A | 3 ff.

For further information on microplates from Greiner Bio-One (e.g. quality aspects, dimensions, application notes), please visit the HTS Know-How Platform on our website: www.gbo.com/bioscience/hts

96 Well Microplates

Since its introduction in the 1960's applications for the 96 well microplate have continually increased to the extent that it is impossible to envisage modern research and industry without it today. Greiner Bio-One has been manufacturing microplates and strip microplates for diagnostics and immunological

research for over 30 years. A large number of different 96 well microplates is available in a wide variety of surface treatments. The spectrum ranges from clear bottom microplates and completely black or white microplates to UV-Star® products.

96 Well Polystyrene Microplates

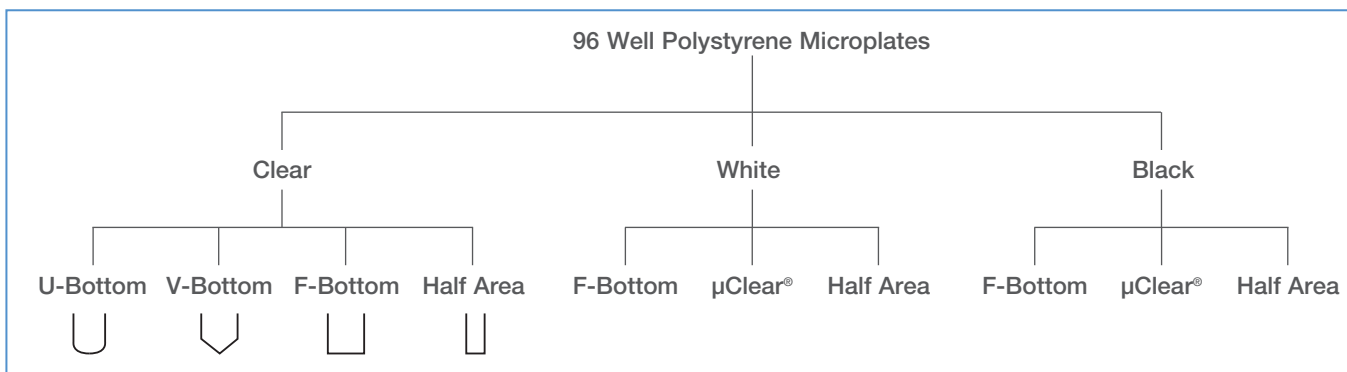

96 well polystyrene microplates are available in the following versions:

- ☞ Sterile or non sterile
- ☞ Cell culture treated (→ p. 1 | 12 ff.)
- ☞ In medium binding or high binding quality (→ p. 3 | 5)
- ☞ In non-binding quality (→ p. 2 | 31)
- ☞ With or without lid

Well Profile

The well profile is a critical aspect in a 96 well microplate. Different well shapes are available for each application (Fig. 1 – Fig. 4):

U-Bottom

The “U” describes the round bottom shape (Fig. 1). U-bottom microplates are ideally suited for agglutination tests.

- ☞ No sharp corners to facilitate easy and residue-free pipetting
- ☞ Suitable for +/- analyses

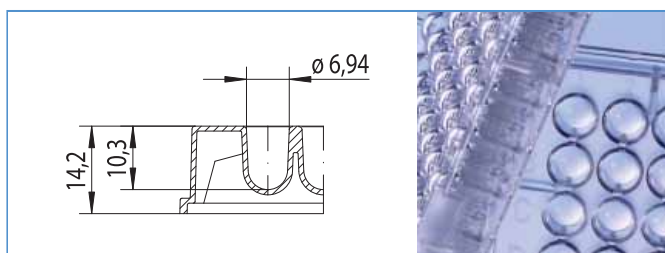

Figure 1:
 Well profile: 96 well U-bottom, polystyrene
 Total volume: 323 µl
 Working volume: 40 – 280 µl

V-Bottom

The “V” stands for the conically tapered well bottom (Fig. 2). These microplates are ideally suited for applications in which the entire sample volume must be pipetted off.

- ☞ For precise pipetting
- ☞ Ideally suited for the storage of samples
- ☞ Suitable for +/- analyses

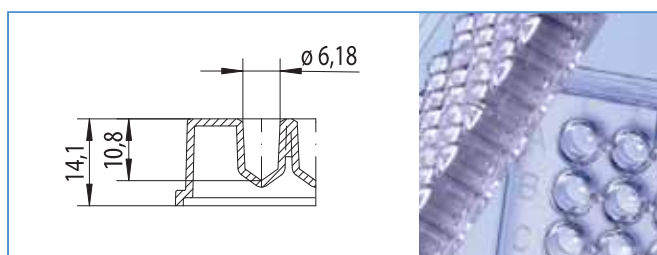

Figure 2:
 Well profile: 96 well V-bottom, polystyrene
 Total volume: 234 µl
 Working volume: 40 – 200 µl

F-Bottom / Standard (ST)

The “F” refers to the flat well bottom (Fig. 3). This well type is ideal for precise optical measurements. The measuring light source is not deflected by the well profile.

- ☞ Excellent optical properties
- ☞ For precise optical measurements
- ☞ For microscopic applications (bottom reading)

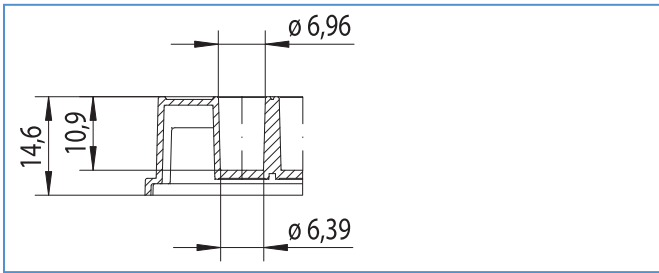

Figure 3:
Well profile: 96 well F-bottom / ST, polystyrene
Total volume: 382 µl
Working volume: 25 – 340 µl
Growth area: 32 mm²

F-Bottom / Chimney Well

The standard flat bottom microplate (Fig. 3) has the same well profile as the chimney well microplate (Fig. 4). The difference from the standard plate is the chimney-like arrangement of the wells. Each well stands on its own (Fig. 5). Therefore the risk of sample carryover and cross contamination is minimised.

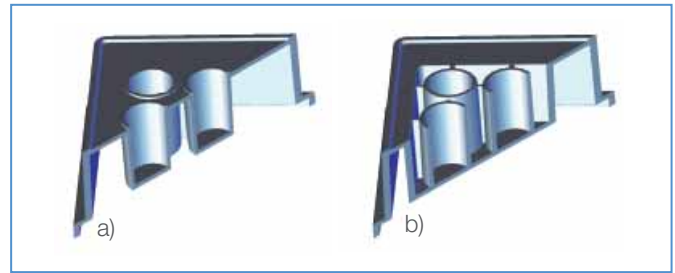

Figure 5:
a) Well profile: 96 well F-bottom / ST, polystyrene
Total volume: 382 µl
Working volume: 25 – 340 µl
Growth area: 32 mm²
b) Well profile: 96 well F-bottom / chimney well, polystyrene
Total volume: 392 µl
Working volume: 25 – 340 µl
Growth area: 34 mm²

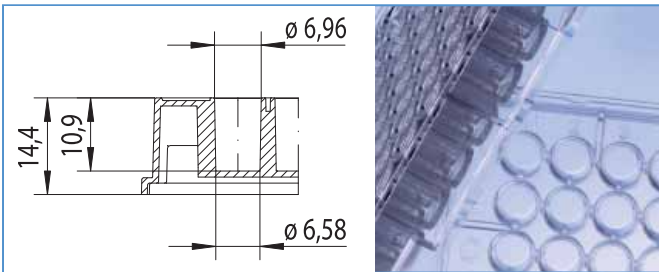
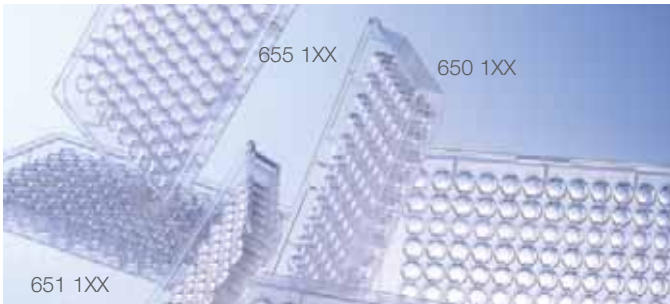

Figure 4:
Well profile: 96 well F-bottom / chimney well, polystyrene
Total volume: 392 µl
Working volume: 25 – 340 µl
Growth area: 34 mm²



96 Well Polystyrene Microplates solid bottom, clear

- ▶ ELISA Microplates, p. 3 | 5
- ▶ Cell Culture Microplates p. 1 | 13

Free of detectable
DNase, RNase,
human DNA
non-pyrogenic

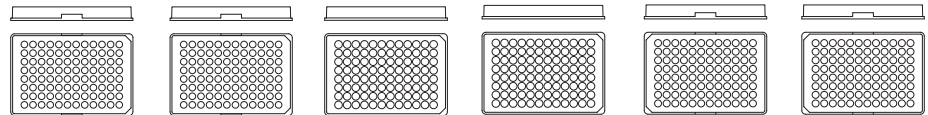

Cat.-No.	650 101	650 161	651 101	651 161	655 101	655 161
Well profile	U-bottom	U-bottom	V-bottom	V-bottom	F-bottom/ST	F-bottom/ST
Bottom	solid	solid	solid	solid	solid	solid
Colour	clear	clear	clear	clear	clear	clear
Binding	-	-	-	-	-	-
Sterile	-	+	-	+	-	+
Lid	-	-	-	-	-	-
Quantity per bag/case	5/100	2/100	5/100	2/100	5/100	2/100

1 Cell/ Tissue Culture
 2 HTS- Microplates
 3 Immunology/ HLA
 4 Microbiology/ Bacteriology
 5 Tubes/Multi-Purpose Beakers
 6 Liquid Handling
 7 Molecular Biology
 8 Protein Crystallisation
 9 Separation
 10 Biochips/ Microfluidics
 11 Cryo-Technics
 12 Lids/Sealers/ CapMats
 13 Reaction Tubes/ Analyser Cups
 14 Accessories

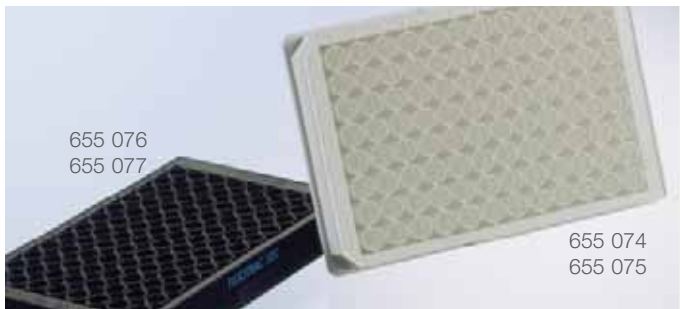

96 Well Polystyrene Microplates solid bottom, white / black

Cell Culture Microplates p. 1 | 14

Free of detectable DNase, RNase, human DNA non-pyrogenic

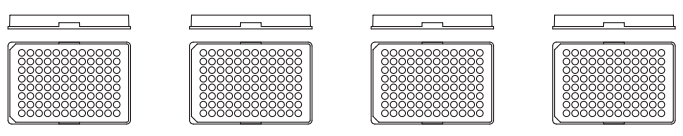

Cat.-No.	655 075	655 074	655 077	655 076
Well profile	F-bottom/ chimney well	F-bottom/ chimney well	F-bottom/ chimney well	F-bottom/ chimney well
Bottom	solid	solid	solid	solid
Colour	white	white	black	black
Binding	LUMITRAC™ 200 med. binding	LUMITRAC™ 600 high binding	FLUOTRAC™ 600 high binding	FLUOTRAC™ 200 med. binding
Sterile	-	+	+	-
Lid	-	-	-	-
Quantity per bag/case	5/40	5/40	5/40	5/40



96 Well Polystyrene Microplates µClear®, white / black

Cell Culture Microplates p. 1 | 15

Cat.-No. 655 096 also available in cycloolefin (Cat.-No. 655 809)

Free of detectable DNase, RNase, human DNA non-pyrogenic

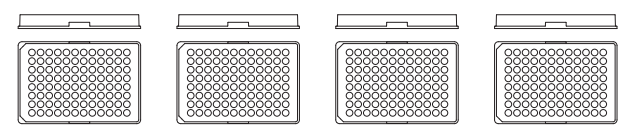

Cat.-No.	655 095	655 094	655 097	655 096
Well profile	F-bottom/ chimney well	F-bottom/ chimney well	F-bottom/ chimney well	F-bottom/ chimney well
Bottom	µClear®	µClear®	µClear®	µClear®
Colour	white	white	black	black
Binding	med. binding	high binding	high binding	med. binding
Sterile	-	+	+	-
Lid	-	-	-	-
Quantity per bag/case	10/40	10/40	10/40	10/40

96 Well Half Area Polystyrene Microplates

For many applications in the laboratory, a reduction of the sample volume is an important criterion. For pharmaceutical drug screening, the simplest way of reducing the sample volume is to use high-format microplates, such as the 384 well or 1536 well microplates. However, many research groups in the development field or companies in the field of ELISA diagnostics shy away from changing to high-format plates, due to the automation that this entails. The 96 well half area microplates offer an interesting alternative here. They can be pipetted manually without any problem but at the same time allow a reduction of the sample volume by up to 50 %. The 96 well half area microplates are available as black, white, clear and μ Clear® microplates in ELISA, HTS and cell culture quality.

Well profile (Fig. 6)

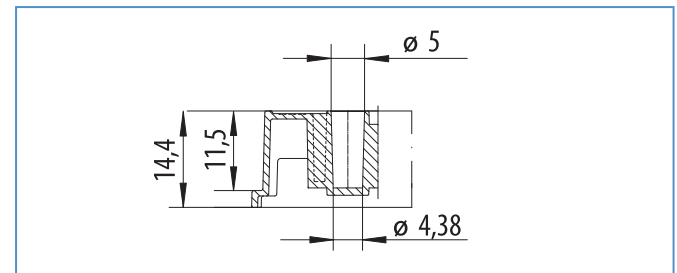

Figure 6:
Well profile: 96 well half area
Total volume: 199 μ l
Working volume: 15 – 175 μ l
Growth area: 15.0 mm²



675 076
675 077

675 094
675 095

96 Well Half Area Microplates

- ▶ Cell Culture Microplates p. 1 | 15
- ▶ Medium binding and high binding quality p. 3 | 5
- ▶ UV-Star® Microplates p. 2 | 37

- Reduction of sample volume by up to 50 %
- Standardised pathlength (1 cm=170 μ l, 0.5 cm=80 μ l)

Free of detectable
DNase, RNase,
human DNA
non-pyrogenic

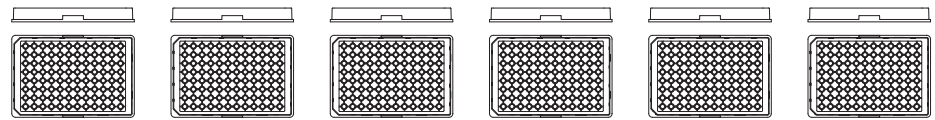

Cat.-No.	675 161	675 101	675 074	675 075	675 077	675 076
Well profile	half area	half area	half area	half area	half area	half area
Bottom	solid	solid	solid	solid	solid	solid
Colour	clear	clear	white	white	black	black
Binding	-	-	high binding	med. binding	high binding	med. binding
Sterile	+	-	+	-	+	-
Lid	-	-	-	-	-	-
Quantity per bag/case	10/40	10/40	10/40	10/40	10/40	10/40

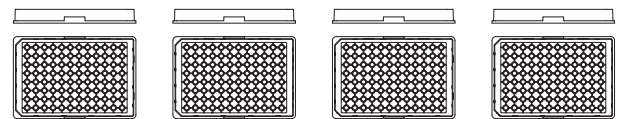

Cat.-No.	675 094	675 095	675 097	675 096
Well profile	half area	half area	half area	half area
Bottom	μ Clear®	μ Clear®	μ Clear®	μ Clear®
Colour	white	white	black	black
Binding	high binding	med. binding	high binding	med. binding
Sterile	+	-	+	-
Lid	-	-	-	-
Quantity per bag/case	10/40	10/40	10/40	10/40

96 Well Polypropylene Microplates

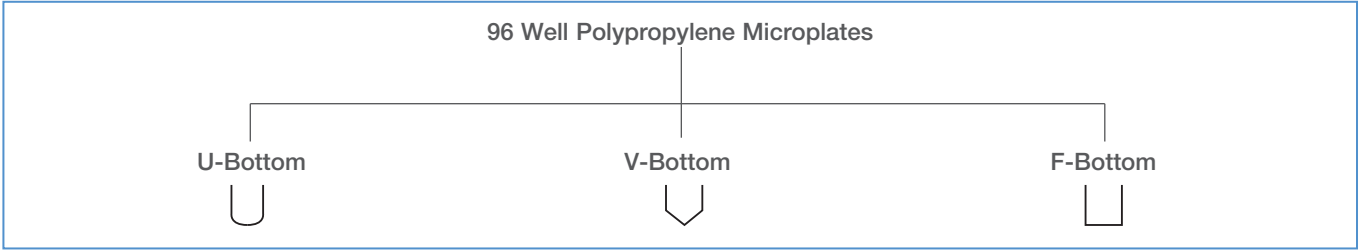

Polypropylene (PP) has low biomolecular binding characteristics, a high temperature tolerance, and is resistant to many standard laboratory chemicals, such as DMSO.

From black polypropylene microplates for fluorescence polarisation to white microplates for scintillation proximity assays (SPA), the 96 well polypropylene range has all you need.

96 well polypropylene microplates are available in the following versions:

- 🌀 Sterile
- 🌀 Non-sterile
- 🌀 Natural, black or white version
- 🌀 Barcode-labelled on request (→ p. 14 | 4)

Polypropylene microplates are ideally suited for the following applications:

- 🌀 Long-term storage of active agents
- 🌀 Storage of DNA or RNA, stock cultures

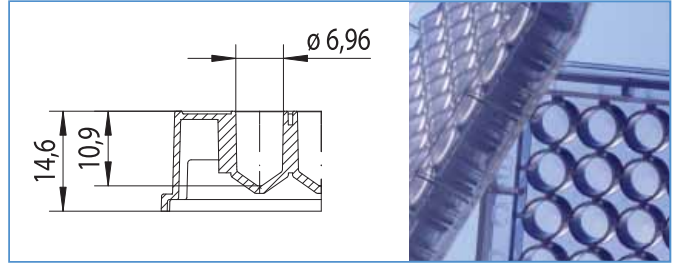

Figure 2:
 Well profile: 96 well V-bottom, polypropylene
 Total volume: 340 µl
 Working volume: 50 – 335 µl

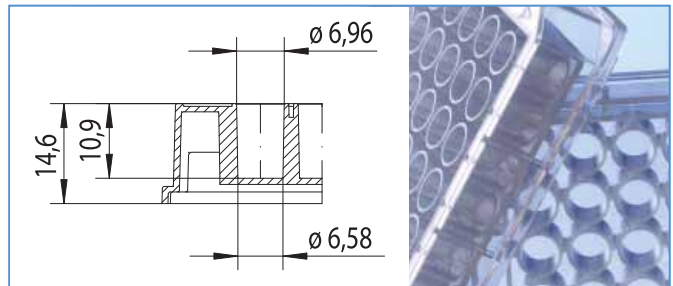

Figure 3:
 Well profile: 96 well F-bottom, polypropylene
 Total volume: 392 µl
 Working volume: 25 – 370 µl

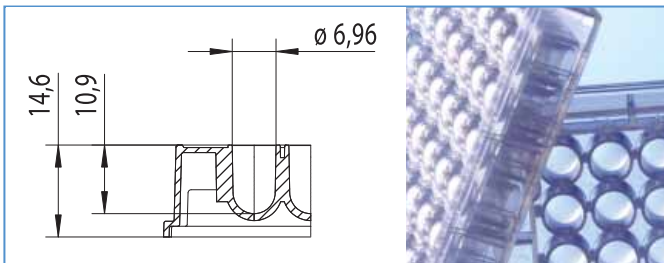

Figure 1:
 Well profile: 96 well U-bottom, polypropylene
 Total volume: 355 µl
 Working volume: 50 – 300 µl



96 Well Polypropylene Microplates U-bottom

- Uniform external dimensions
- Well-to-well spacing 9 mm
- Alphanumeric well coding
- High chemical resistance
- High temperature resistance (-196 °C to +121 °C)
- Sealable with adhesive films and heat sealer
- Sealable with CapMats (→ p. 12 | 7)

Free of detectable
DNase, RNase,
human DNA
non-pyrogenic

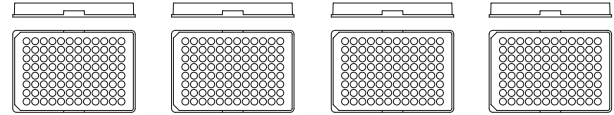

Cat.-No.	650 201	650 261	650 207	650 209
Well profile	U-bottom/ chimney well	U-bottom/ chimney well	U-bottom/ chimney well	U-bottom/ chimney well
Bottom	solid	solid	solid	solid
Colour	natural	natural	white	black
Binding	-	-	-	-
Sterile	-	+	-	-
Lid	-	-	-	-
Quantity per bag/case	10/100	10/100	10/100	10/100



96 Well Polypropylene Microplates F-bottom / V-bottom

- Uniform external dimensions
- Well-to-well spacing 9 mm
- Alphanumeric well coding
- High chemical resistance
- High temperature resistance (-196 °C to +121 °C)
- Sealable with adhesive films and heat sealer
- Sealable with CapMats (→ p. 12 | 7)

Free of detectable
DNase, RNase,
human DNA
non-pyrogenic

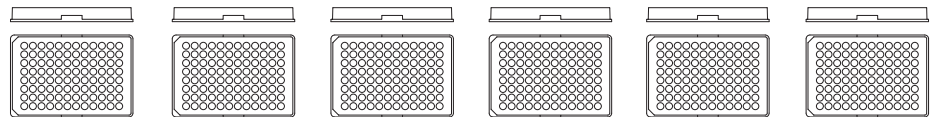

Cat.-No.	655 201	655 207	655 209	651 201	651 207	651 209
Well profile	F-bottom/ chimney well	F-bottom/ chimney well	F-bottom/ chimney well	V-bottom/ chimney well	V-bottom/ chimney well	V-bottom/ chimney well
Bottom	solid	solid	solid	solid	solid	solid
Colour	natural	white	black	natural	white	black
Binding	-	-	-	-	-	-
Sterile	-	-	-	-	-	-
Lid	-	-	-	-	-	-
Quantity per bag/case	10/100	10/100	10/100	10/100	10/100	10/100

384 Well Microplates

Drug screening has undergone rapid development over the past few years. The number of tests with new targets and the number of active agents to be tested is constantly increasing. Volume reduction, simple testing and cost savings are some of the highest priorities and high format microplates with a low well volume are one of the most important tools in achieving this. One of the first higher format microplates was the 384 well plate, launched by Greiner Bio-One in 1994/1995. Compared with the 96 well standard microplate, the number of wells is quadrupled in this microplate, combined with a volume

reduction from 382 μl to 131 μl . The well-to-well spacing is 4.5 mm (96 well plate: 9 mm). The external dimensions of the 384 well microplates are compatible with standard equipment and automated systems.

The 384 well microplates are available as black and white clear bottom plates ($\mu\text{Clear}^{\text{®}}$), in FLUOTRAC[™], LUMITRAC[™], MICROLON[®], CELLSTAR[®], UV-Star[®] or non-binding quality.

384 Well Polystyrene Microplates

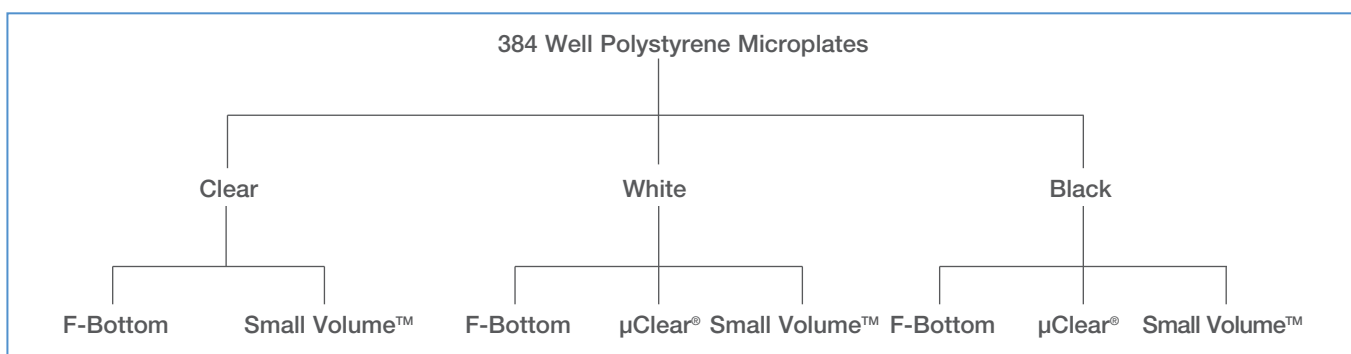

384 well microplates are available in the following versions:

- ☞ Sterile or non sterile
- ☞ Cell culture treated (→ p. 1 | 16 ff.)
- ☞ In medium binding or high binding quality
- ☞ In non-binding quality (→ p. 2 | 32)
- ☞ In UV-Star[®] quality (→ p. 2 | 37)
- ☞ With or without lid
- ☞ Barcode-labelled on request (→ p. 14 | 4)

Improved Rounded Square Well Design

All wells of the 384 well microplates, with the exception of the 384 well Small Volume[™] microplate, are rounded square wells, i.e. they are square with rounded corners (Fig. 2).

This design combines the advantages of the square well, i.e. flexible working volume of 15 – 110 μl , with the advantages of a round well, such as reduced wicking and bubbling.

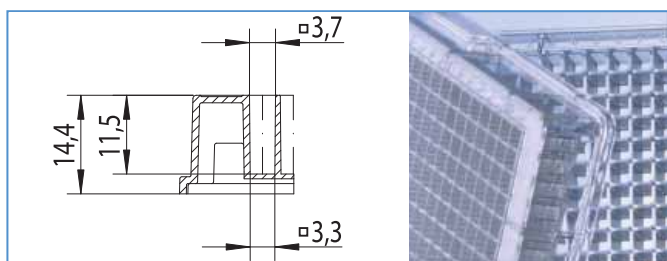

Figure 1:
 Well profile: 384 well, polystyrene
 Total volume: 131 μl
 Working volume: 15 – 110 μl
 Growth area: 10 mm²

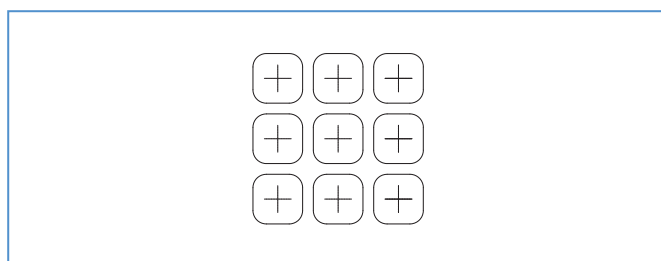

Figure 2:
 Rounded square well design with improved corner radius of 1 mm



781 061, 781 1XX

384 Well Polystyrene Microplates solid bottom, clear

↳ Cell Culture Microplates p. 1 | 16

Free of detectable
DNase, RNase,
human DNA
non-pyrogenic

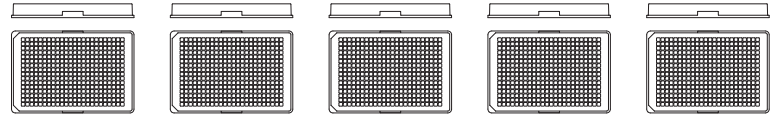

Cat.-No.	781 101	781 061	781 162	781 185	781 186
Well profile	F-bottom	F-bottom	F-bottom	F-bottom	F-bottom
Bottom	solid	solid	solid	solid	solid
Colour	clear	clear	clear	clear	clear
Binding	-	high binding	-	-	-
Sterile	-	+	+	+	+
Lid	-	-	-	+	+
Quantity per bag/case	10/100	10/40	10/100	1/32	8/32

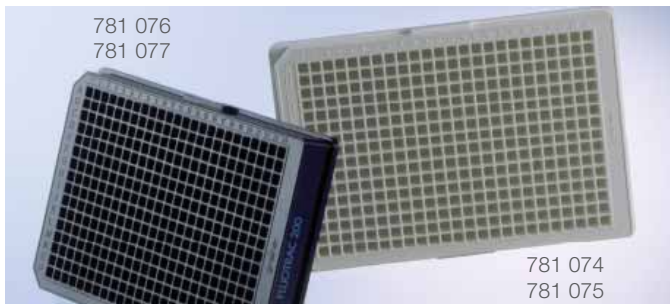
781 076
781 077

384 Well Polystyrene Microplates solid bottom, white / black

↳ Cell Culture Microplates p. 1 | 16

Free of detectable
DNase, RNase,
human DNA
non-pyrogenic

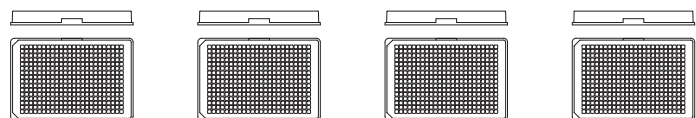

Cat.-No.	781 074	781 075	781 077	781 076
Well profile	F-bottom	F-bottom	F-bottom	F-bottom
Bottom	solid	solid	solid	solid
Colour	white	white	black	black
Binding	LUMITRAC™ 600 high binding	LUMITRAC™ 200 med. binding	FLUOTRAC™ 600 high binding	FLUOTRAC™ 200 med. binding
Sterile	+	-	+	-
Lid	-	-	-	-
Quantity per bag/case	10/40	10/40	10/40	10/40

1 Cell/
Tissue Culture

2 HTS-
Microplates

3 Immunology/
HLA

4 Microbiology/
Bacteriology

5 Tubes/Multi-
Purpose Beakers

6 Liquid
Handling

7 Molecular
Biology

8 Protein
Crystallisation

9 Separation

10 Biochips/
Microfluidics

11 Cryo-
Technics

12 Lids/Sealers/
CapMats

13 Reaction Tubes/
Analyser Cups

14 Accessories



384 Well Polystyrene Microplates

µClear®, white / black

- ▶ Cell Culture Microplates p. 1 | 17
- ▶ UV-Star® Microplates p. 2 | 37

Free of detectable
DNase, RNase,
human DNA
non-pyrogenic

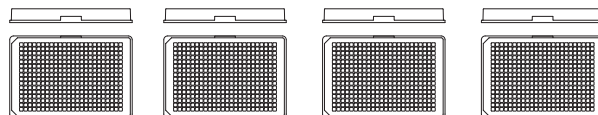

Cat.-No.	781 094	781 095	781 097	781 096
Well profile	F-bottom	F-bottom	F-bottom	F-bottom
Bottom	µClear®	µClear®	µClear®	µClear®
Colour	white	white	black	black
Binding	high binding	med. binding	high binding	med. binding
Sterile	+	-	+	-
Lid	-	-	-	-
Quantity per bag/case	10/40	10/40	10/40	10/40

384 Well Polypropylene Microplates

Polypropylene (PP) has low biomolecular binding characteristics, a high temperature tolerance and is resistant to many standard laboratory chemicals, such as DMSO.

From black polypropylene microplates for fluorescence to white microplates for luminescence assays, the 384 well polypropylene programme has all you need.

384 well polypropylene microplates are available in the following versions:

- ☞ Sterile
- ☞ Non-sterile
- ☞ Natural, black or white
- ☞ Barcode-labelled on request (→ p. 14 | 4)

In addition to the 384 Deep Well MASTERBLOCK® (→ p. 2 | 26), 384 well F-bottom (Fig. 1) and V-bottom (Fig. 2) polypropylene microplates extend the range of polypropylene microplates.

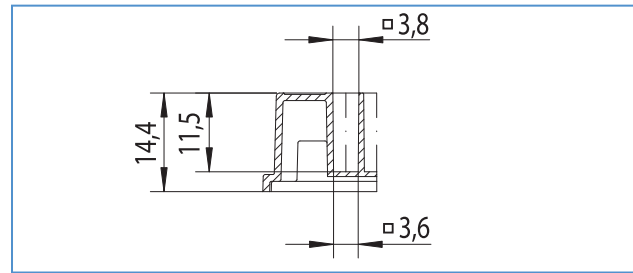

Figure 1:
Well profile: 384 well F-bottom, polypropylene
Total volume: 152 µl
Working volume: 15 – 145 µl

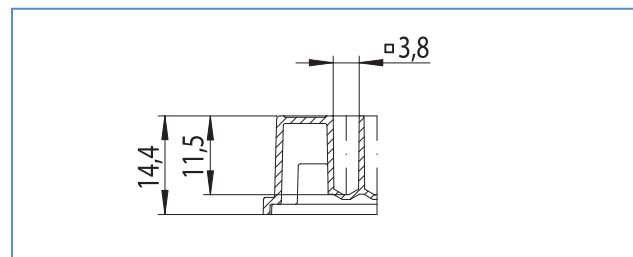
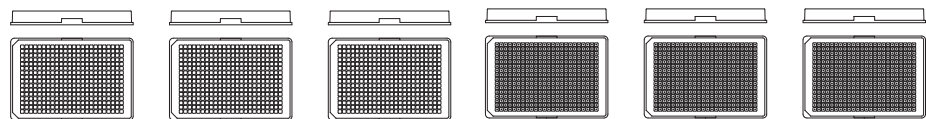

Figure 2:
Well profile: 384 well V-bottom, polypropylene
Total volume: 130 µl
Working volume: 13 – 120 µl



384 Well Polypropylene Microplates solid bottom, natural / white / black

Free of detectable
DNase, RNase,
human DNA
non-pyrogenic



Cat.-No.	781 201	781 207	781 209	781 280	781 287	781 289
Well profile	F-bottom	F-bottom	F-bottom	V-bottom	V-bottom	V-bottom
Bottom	solid	solid	solid	solid	solid	solid
Colour	natural	white	black	natural	white	black
Binding	-	-	-	-	-	-
Sterile	-	-	-	-	-	-
Lid	-	-	-	-	-	-
Quantity per bag/case	10/100	10/100	10/100	10/100	10/100	10/100

384 Well Small Volume™ LoBase and HiBase Polystyrene Microplates

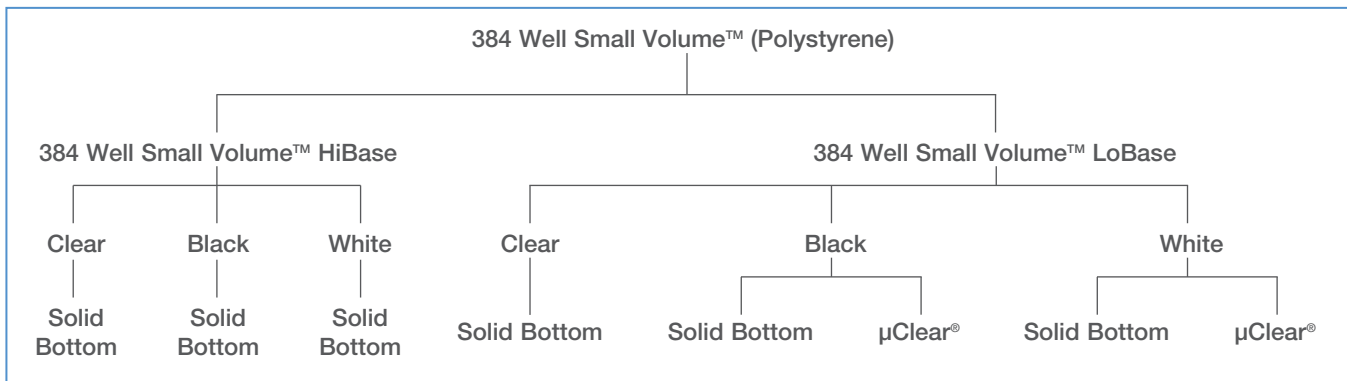

A small sample volume is an important goal in high-throughput screening. The substances to be tested and the reagents used are usually scarce, expensive and time-consuming to produce. In addition to a high degree of automation and the use of sensitive reader systems, the introduction of higher format microplates, such as the 384 well or the 1536 well microplate, has made a decisive contribution to reducing the sample volume.

The potential for savings in the 384 well microplate with an average working volume of 70 – 80 μl is relatively limited and successful use of 1536 well microplates requires considerable optimisation work on the instrumentation to be used. In order to enable a savings potential in the 384 well format comparable to a 1536 well microplate, Greiner Bio-One developed a new platform with the 384 well Small Volume™ microplates. They have round wells with a conical geometry (Fig. 1 and Fig. 2). The wells have a total volume of 28 μl and a working volume of between 4 μl and 25 μl . Two different 384 well Small Volume™ microplate versions are available:

384 well Small Volume™ HiBase polystyrene microplates:

- Perfect for top reading even at low working volumes
- Savings in reagent similar to 1536 well microplates
- Suited for transmission, fluorescence and luminescence applications
- Excellent optical properties
- Available in med. binding or high binding quality (MICROLON®, FLUOTRAC™, LUMITRAC™)
- Available cell culture treated (→ p. 1 | 17)
- Available in non-binding quality (→ p. 2 | 32)

384 well Small Volume™ LoBase polystyrene microplates:

- Perfect for bottom reading even at low working volumes
- Savings in reagent similar to 1536 well microplates
- Suited for transmission, fluorescence and luminescence applications
- Excellent optical properties
- Available cell culture treated (→ p. 1 | 17)
- Available in med. binding or high binding quality

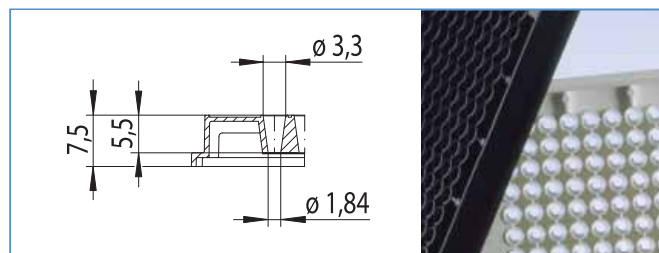

Figure 2:
Well profile: 384 well Small Volume™, LoBase
Total volume: 28 μl
Working volume: 4 – 25 μl
Growth area: 2.7 mm^2

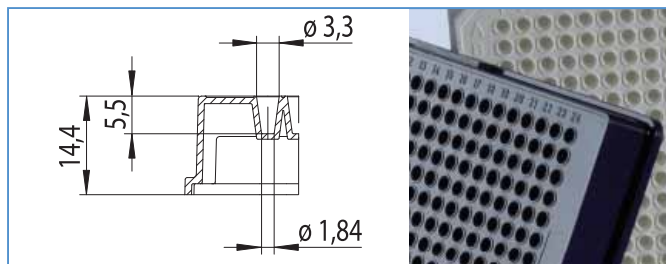

Figure 1:
Well profile: 384 well Small Volume™, HiBase
Total volume: 28 μl
Working volume: 4 – 25 μl
Growth area: 2.7 mm^2



384 Well Small Volume™ HiBase Polystyrene Microplates

Cell Culture Microplates p. 1 | 17

Free of detectable
DNase, RNase,
human DNA
non-pyrogenic

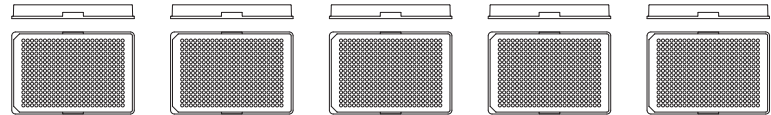

Cat.-No.	784 101	784 075	784 075-25	784 076	784 076-25
Well profile	Small Volume™	Small Volume™	Small Volume™	Small Volume™	Small Volume™
Bottom	solid	solid	solid	solid	solid
Colour	clear	white	white	black	black
Binding	-	med. binding	med. binding	med. binding	med. binding
Sterile	-	-	-	-	-
Lid	-	-	-	-	-
Quantity per bag/case	10/40	10/40	25/150	10/40	25/150
Plate design	HiBase	HiBase	HiBase	HiBase	HiBase



384 Well Small Volume™ LoBase Polystyrene Microplates

Cell Culture Microplates p. 1 | 17

Cat.-No. 788 096 also available in cycloolefin
(Cat.-No. 788 876)

Free of detectable
DNase, RNase,
human DNA
non-pyrogenic

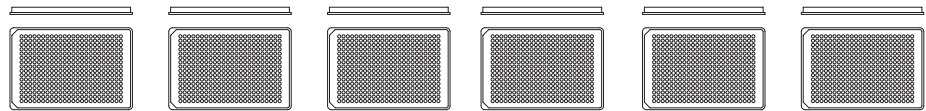

Cat.-No.	788 101	788 161	788 075	788 076	788 095	788 096
Well profile	Small Volume™	Small Volume™	Small Volume™	Small Volume™	Small Volume™	Small Volume™
Bottom	solid	solid	solid	solid	µClear®	µClear®
Colour	clear	clear	white	black	white	black
Binding	-	-	med. binding	med. binding	med. binding	med. binding
Sterile	-	+	-	-	-	-
Lid	-	-	-	-	-	-
Quantity per bag/case	10/80	10/80	10/80	10/80	10/80	10/80
Plate design	LoBase	LoBase	LoBase	LoBase	LoBase	LoBase

384 Deep Well Small Volume™ Polypropylene Microplate

The 384 Deep Well Small Volume™ polypropylene microplate offers new possibilities for drug discovery:

- ☞ Standardised plate geometry (conform to ANSI 1-2004)
- ☞ Large working volume from 1 µl to 90 µl (Fig. 1)
- ☞ Dead volume below 1 µl
- ☞ Focused liquid samples (Fig. 2)
- ☞ No loss of valuable compounds

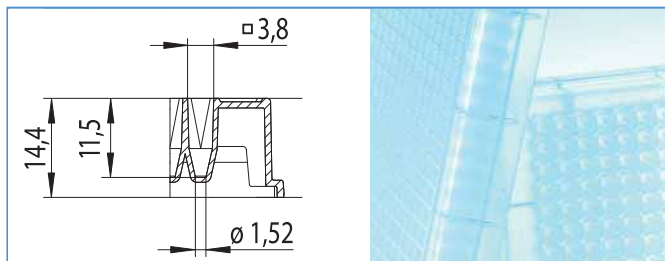

Figure 1:
Well profile: 384 Deep Well Small Volume™
Total volume: 107 µl (21 µl in the frustrum)
Working volume: 1 – 90 µl

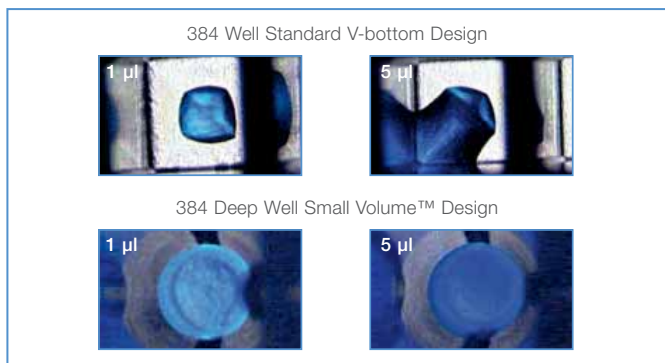

Figure 2: Location of liquid at the bottom of different microplate wells

The 384 Deep Well Small Volume™ polypropylene microplate is especially suited

☞ For direct compound transfer and preparation of assay-ready plates:

The focused aggregation of even small sample volumes in the well centres (Fig. 2) allows the transfer of small amounts of highly concentrated compound solutions with pin tools or capillary-based liquid handling systems. Direct compound transfer of 50 nl from storage to assay plate is possible and pre-dilution of concentrated compounds becomes redundant.

☞ For pre-dilutions:

If pre-dilution of compounds is required by the application, e.g. for sensitive cell-based assays, the working volume of 90 µl allows a high dilution under the cell toxicity level of DMSO.

☞ As storage plate:

Polypropylene, the base polymer of the 384 Deep Well Small Volume™ microplate has low binding characteristics, a high temperature tolerance, and is resistant to many standard laboratory chemicals, such as DMSO.

☞ For sealing:

The square well geometry at the top of the wells with pronounced sealing rims facilitates heat sealing.

☞ For automation:

The standardised microplate footprint and well geometry enables efficient integration with automated systems.



Further information on 384 Deep Well Small Volume™ Polypropylene Microplates
→ **Forum No. 11: 384 Well Storage Plate**
reducing compound consumption and supporting assay miniaturisation (F073 000)

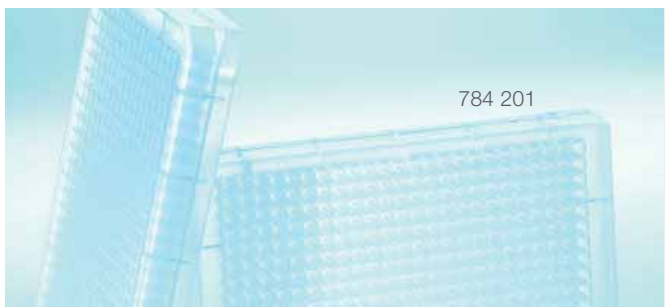

384 Deep Well Small Volume™ Polypropylene Microplate

- White and black versions are available on request

Free of detectable
DNase, RNase,
human DNA
non-pyrogenic

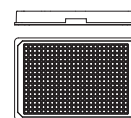

Cat.-No.	784 201
Well profile	Small Volume™
Bottom	solid
Colour	natural
Sterile	-
Lid	-
Quantity per bag/case	10/100
Plate design	Deep Well

1536 Well Microplates

The highest possible degree of automation, optimal performance and cost savings continue to be the requirements placed on microplates for high-throughput screening. In 1997, shortly after the launch of the 384 well microplates, Greiner Bio-One was the first manufacturer to introduce another innovative microplate format – the 1536 well microplate. The external dimensions were the same as those used in the 96 well and 384 well microplates. However, to utilise the available space most efficiently, the number of wells was increased fourfold from 384 to 1536.

Close cooperation with numerous users has now led to the development of a broad product range, and the constant drive towards improvements in quality has, for example, led to a reduction in curvature of the plates to < 100 µm. The 1536 well microplates are available as clear bottom variants, in clear polystyrene and completely black or white in CELLSTAR®, LUMITRAC™, FLUOTRAC™ and non-binding quality. The product range has been further expanded by a 1536 Deep Well polypropylene microplate (→ p. 2 | 27).

1536 Well Polystyrene Microplates

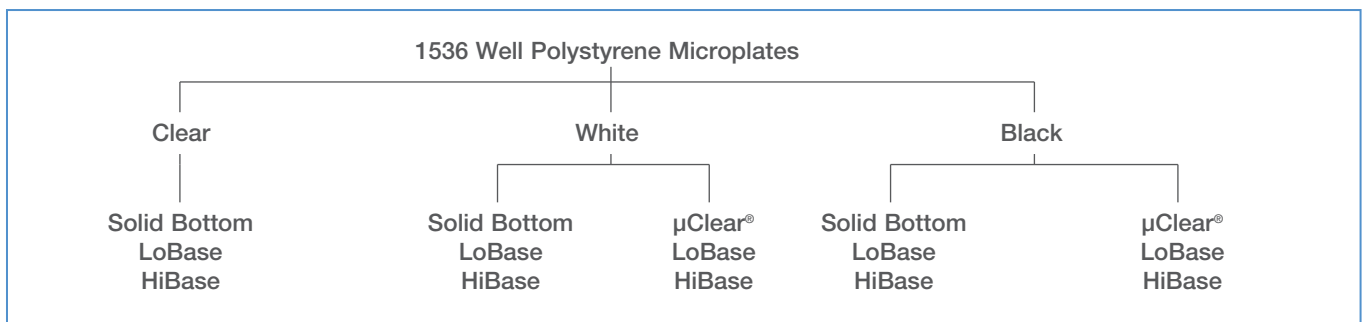

1536 well polystyrene microplates are available in the following versions:

- ☞ Sterile
- ☞ Non-sterile
- ☞ Cell culture treated (→ p. 1 | 18 f.)
- ☞ In medium binding or high binding quality
- ☞ With or without lid

1536 well HiBase microplates (Fig. 2):

- ☞ Ideally suited for top reading even at low working volumes
- ☞ Suited for transmission, fluorescence and luminescence applications
- ☞ Excellent optical properties

1536 Well LoBase and HiBase Microplates

Two versions of the 1536 well microplates have been developed, the LoBase version and the HiBase version. In both versions, the total well volume is 12.6 µl, with a working volume of 3 – 10 µl.

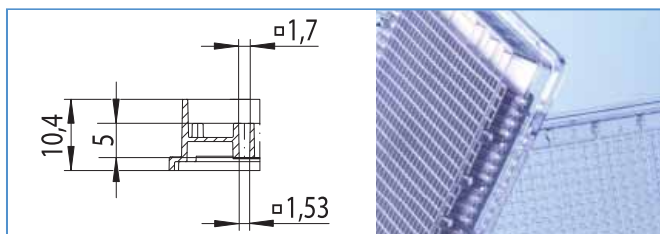

Figure 1:
Well profile: 1536 well, LoBase
Total volume: 12.6 µl
Working volume: 3 – 10 µl
Growth area: 2.3 mm²

1536 well LoBase microplates (Fig. 1):

- ☞ Ideally suited for bottom reading even at low working volumes
- ☞ Suited for transmission, fluorescence and luminescence applications
- ☞ Excellent optical properties

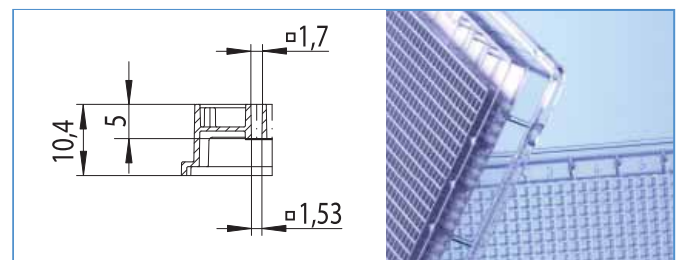

Figure 2:
Well profile: 1536 well, HiBase
Total volume: 12.6 µl
Working volume: 3 – 10 µl
Growth area: 2.3 mm²

All wells of the 1536 well microplates are rounded square wells, i.e. they are square with rounded corners (Fig. 3). This design combines the advantages of the square well, i.e. a flexible working volume of 3 – 10 µl with the advantages of a round well, such as reduced wicking and bubbling.

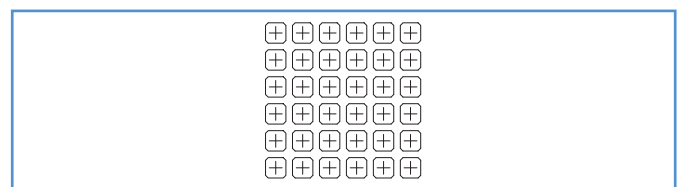

Figure 3:
The rounded square well design

1 Cell/
Tissue Culture

2 HTS-
Microplates

3 Immunology/
HLA

4 Microbiology/
Bacteriology

5 Tubes/Multi-
Purpose Beakers

6 Liquid
Handling

7 Molecular
Biology

8 Protein
Crystallisation

9 Separation

10 Biochips/
Microfluidics

11 Cryo-
Technics

12 Lids/Sealers/
CapMats

13 Reaction Tubes/
Analyser Cups

14 Accessories

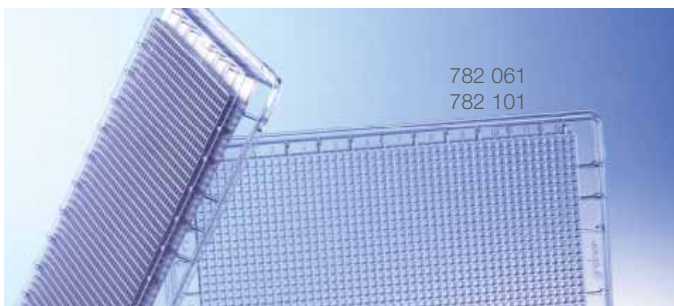

1536 Well HiBase Microplates solid bottom, clear / white / black

Cell Culture Microplates p. 1 | 18

Free of detectable
DNase, RNase,
human DNA
non-pyrogenic

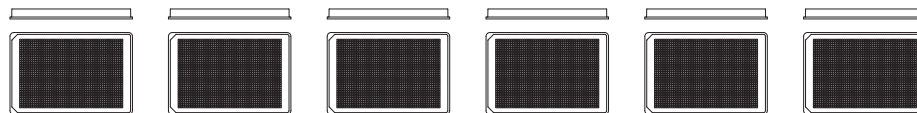

Cat.-No.	782 101	782 061	782 075	782 074	782 076	782 077
Well profile	F-bottom	F-bottom	F-bottom	F-bottom	F-bottom	F-bottom
Bottom	solid	solid	solid	solid	solid	solid
Colour	clear	clear	white	white	black	black
Binding	-	MICROLON® 600 high binding	LUMITRAC™ 200 med. binding	LUMITRAC™ 600 high binding	FLUOTRAC™ 200 med. binding	FLUOTRAC™ 600 high binding
Sterile	-	+	-	+	-	+
Lid	-	-	-	-	-	-
Quantity per bag/case	15/60	15/60	15/60	15/60	15/60	15/60
Plate design	HiBase	HiBase	HiBase	HiBase	HiBase	HiBase



1536 Well HiBase Microplates µClear®, white / black

Cell Culture Microplates p. 1 | 18

1536 Well SCREENSTAR Microplate p. 1 | 20

Free of detectable
DNase, RNase,
human DNA
non-pyrogenic

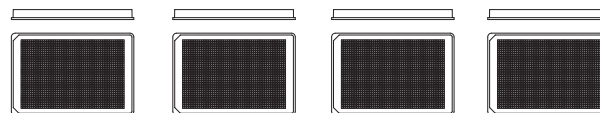

Cat.-No.	782 095	782 094	782 097	782 096
Well profile	F-bottom	F-bottom	F-bottom	F-bottom
Bottom	µClear®	µClear®	µClear®	µClear®
Colour	white	white	black	black
Binding	med. binding	high binding	high binding	med. binding
Sterile	-	+	+	-
Lid	-	-	-	-
Quantity per bag/case	15/60	15/60	15/60	15/60
Plate design	HiBase	HiBase	HiBase	HiBase



1536 Well LoBase Microplates

solid bottom, clear / white / black
 μ Clear[®], white / black

- ▶ Cell Culture Microplates p. 1 | 19
- ▶ 1536 Well SCREENSTAR Microplate p. 1 | 20
- ▶ Available in high binding quality on request

Free of detectable
 DNase, RNase,
 human DNA
 non-pyrogenic

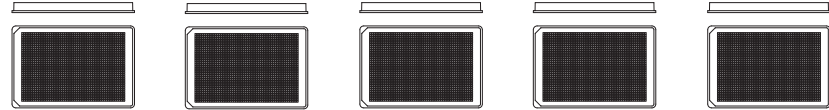

Cat.-No.	783 101	783 075	783 076	783 095	783 096
Well profile	F-bottom	F-bottom	F-bottom	F-bottom	F-bottom
Bottom	solid	solid	solid	μ Clear [®]	μ Clear [®]
Colour	clear	white	black	white	black
Binding	-	LUMITRAC™ 200 med. binding	FLUOTRAC™ 200 med. binding	med. binding	med. binding
Sterile	-	-	-	-	-
Lid	-	-	-	-	-
Quantity per bag/case	15/60	15/60	15/60	15/60	15/60
Plate design	LoBase	LoBase	LoBase	LoBase	LoBase

Storage Plates

Greiner Bio-One polypropylene microplates are perfect storage plates for active agents, patient samples or biomolecules. Their most important properties are biological inertness, resistance to numerous solvents commonly used in the laboratory, such as DMSO and temperature resistance from -196 °C to +121 °C.

The footprint is compatible with automated systems. The microplates are also characterised by elevated well walls which make it possible to easily seal them.

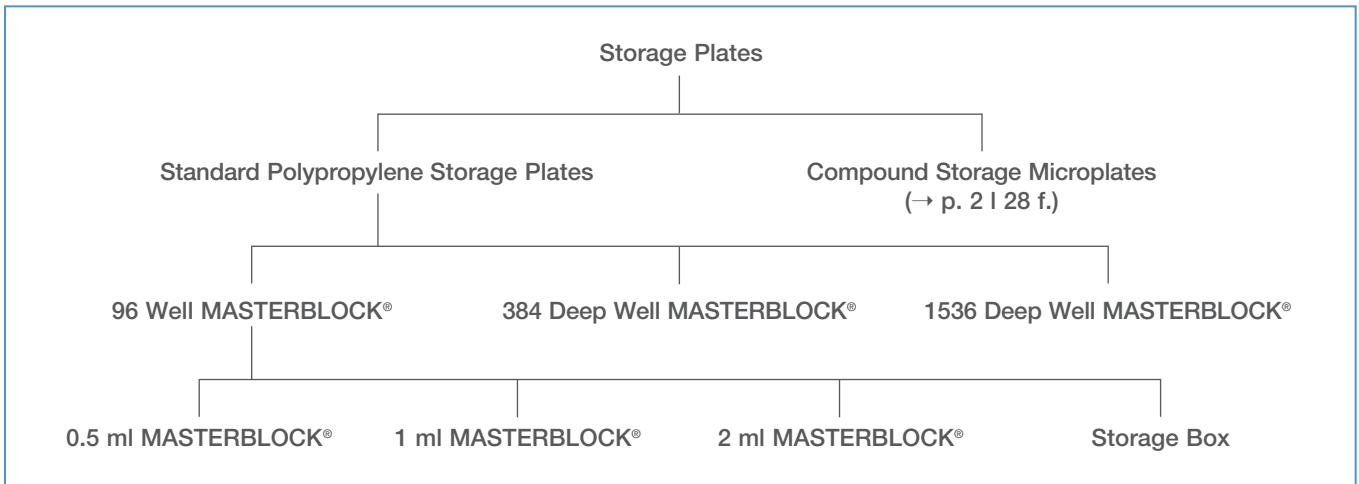

- Further 96 well polypropylene microplates can be found on p. 2 | 10
- Further 384 well polypropylene microplates can be found on p. 2 | 15

- Compound storage microplates can be found on p. 2 | 28

96 Well Polypropylene MASTERBLOCK®

The 0.5 ml, 1 ml, and 2 ml MASTERBLOCK® (Fig. 1 – 3) are ideal microplates for storing non-human sample material but are also ideal for cultivating bacteria or yeast.

- Uniform external dimensions and tolerances
- Alphanumeric well coding
- High chemical resistance
- High temperature resistance (-196 °C to +121 °C)
- Sealable with adhesive films and heat sealer
- Sealable with CapMats (→ p. 12 | 7)
- Available in natural, red, green, yellow or blue
- Available sterile or non-sterile
- Barcode-labelled on request (→ p. 14 | 4)

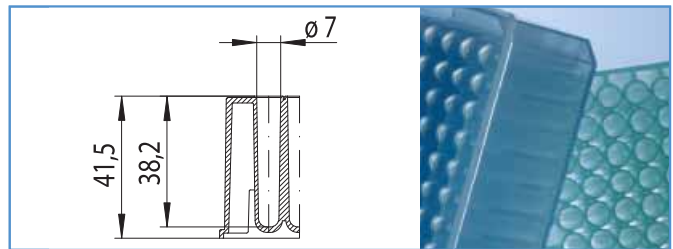

Figure 2:
 Well profile: 1 ml MASTERBLOCK®, polypropylene
 Total volume: 1.22 ml
 Working volume: 0.05 – 1.1 ml (at RT)
 0.05 – 1.0 ml (at -20 °C)

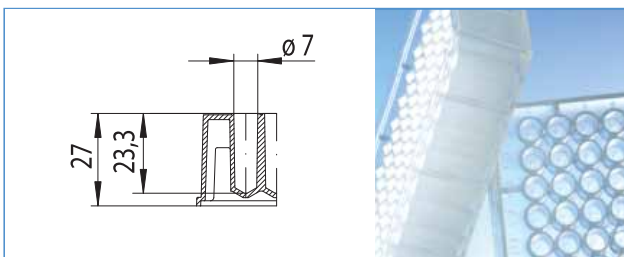

Figure 1:
 Well profile: 0.5 ml MASTERBLOCK®, polypropylene
 Total volume: 0.78 ml
 Working volume: 0.03 – 0.65 ml (at RT)
 0.03 – 0.55 ml (at -20 °C)

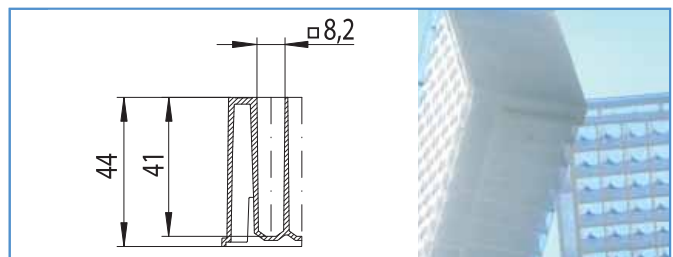

Figure 3:
 Well profile: 2 ml MASTERBLOCK®, polypropylene
 Total volume: 2.42 ml
 Working volume: 0.1 – 2.1 ml (at RT)
 0.1 – 2.0 ml (at -20 °C)



96 Well MASTERBLOCK® 1 ml

▶ 96 Well Polypropylene Microplates p. 2 | 10

▶ CapMats p. 12 | 7

Free of detectable
DNase, RNase,
human DNA
non-pyrogenic

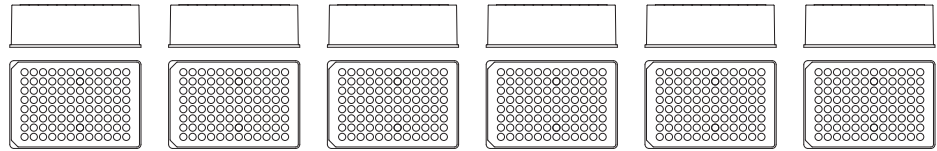

Cat.-No.	780 201	780 215	780 206	780 203	780 204	780 205
Volume [ml]	1	1	1	1	1	1
Well profile	U-bottom	U-bottom	U-bottom	U-bottom	U-bottom	U-bottom
Bottom	solid	solid	solid	solid	solid	solid
Colour	natural	natural	yellow	red	blue	green
Binding	-	-	-	-	-	-
Sterile	-	-	-	-	-	-
Suitable CapMats, Cat.-No.	381 070, 381 061	381 070, 381 061	381 070, 381 061	381 070, 381 061	381 070, 381 061	381 070, 381 061
Quantity per bag/case	1/50	5/50	1/50	1/50	1/50	1/50

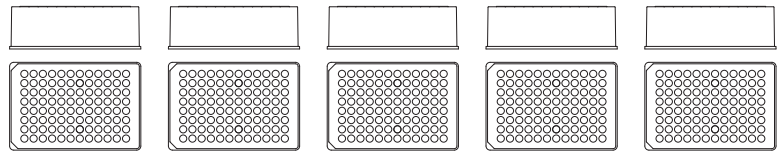

Cat.-No.	780 261	780 263	780 264	780 265	780 266
Volume [ml]	1	1	1	1	1
Well profile	U-bottom	U-bottom	U-bottom	U-bottom	U-bottom
Bottom	solid	solid	solid	solid	solid
Colour	natural	red	blue	green	yellow
Binding	-	-	-	-	-
Sterile	+	+	+	+	+
Suitable CapMats, Cat.-No.	381 070, 381 061	381 070, 381 061	381 070, 381 061	381 070, 381 061	381 070, 381 061
Quantity per bag/case	1/50	1/50	1/50	1/50	1/50

1 Cell/
Tissue Culture

2 HTS-
Microplates

3 Immunology/
HLA

4 Microbiology/
Bacteriology

5 Tubes/Multi-
Purpose Beakers

6 Liquid
Handling

7 Molecular
Biology

8 Protein
Crystallisation

9 Separation

10 Biochips/
Microfluidics

11 Cryo-
Technics

12 Lids/Sealers/
CapMats

13 Reaction Tubes/
Analyser Cups

14 Accessories



96 Well MASTERBLOCK®
2 ml and 0.5 ml

- ▶ 96 Well Polypropylene Microplates p. 2 | 10
- ▶ CapMats p. 12 | 7

Free of detectable
DNase, RNase,
human DNA
non-pyrogenic

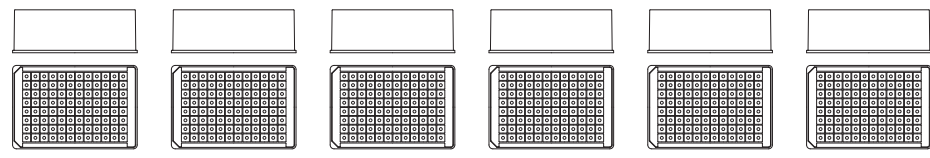

Cat.-No.	780 270	780 271	780 273	780 274	780 275	780 276
Volume [ml]	2	2	2	2	2	2
Well profile	V-bottom	V-bottom	V-bottom	V-bottom	V-bottom	V-bottom
Bottom	solid	solid	solid	solid	solid	solid
Colour	natural	natural	red	blue	green	yellow
Binding	-	-	-	-	-	-
Sterile	-	+	+	+	+	+
Suitable CapMats, Cat.-No.	381 080, 381 081	381 080, 381 081	381 080, 381 081	381 080, 381 081	381 080, 381 081	381 080, 381 081
Quantity per bag/case	1/50	1/50	1/50	1/50	1/50	1/50



Cat.-No.	780 285	Cat.-No.	786 201	786 261
Volume [ml]	2	Volume [ml]	0.5	0.5
Well profile	V-bottom	Well profile	V-bottom	V-bottom
Bottom	solid	Bottom	solid	solid
Colour	natural	Colour	natural	natural
Binding	-	Binding	-	-
Sterile	-	Sterile	-	+
Suitable CapMats, Cat.-No.	381 080, 381 081	Suitable CapMats, Cat.-No.	381 070, 381 061	381 070, 381 061
Quantity per bag/case	5/50	Quantity per bag/case	8/80	1/80

96 Well Storage Box

The Greiner Bio-One storage box system in microplate format meets all requirements. It comes with a coding card, which enables proper storage of samples, and the temperature resistance of the polypropylene vessels from -80 °C to +121 °C provides for a broad range of applications. All components of the storage box are autoclavable. The box has space for 96 vessels with a capacity of 1.3 ml each.

The individual vessels are made of biologically inert polypropylene, while the storage box itself is made of polycarbonate (PC). The storage box comes with a lid, ID-card and with/without 96 PP-vessels with mounted adhesive strips, and can be supplied both sterile and non-sterile.

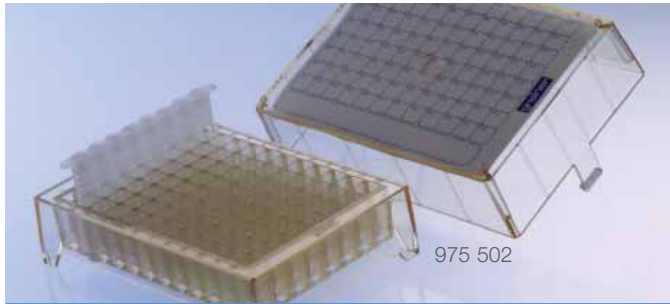

96 Well Storage Box

↳ Tubes for Storage Box p. 5 | 4

Cat.-No.	975 502	975 561	975 570
Material	PC	PC	PC
Incl. 96 polypropylene vessels, inserted	-	+	+
Sterile	-	+	-
ID card	+	+	+
Quantity per bag/case	1	50	50

384 Deep Well Polypropylene MASTERBLOCK®

In addition to the 384 well polypropylene microplates with F-bottom and V-bottom, a 384 well MASTERBLOCK® extends the range of polypropylene microplates. The innovative design of the Deep Well MASTERBLOCK® enables numerous applications in which larger volumes are required. The MASTERBLOCK® is ideal for compound libraries and the storage of samples in general. The conical shape of the wells (Fig. 1 and 2) enables precise pipetting down to the last drop. The standardised external dimensions and the tight tolerances make liquid handling easier for robotics. The MASTERBLOCK® is also available barcode-labelled on request (→ p. 14 | 4).

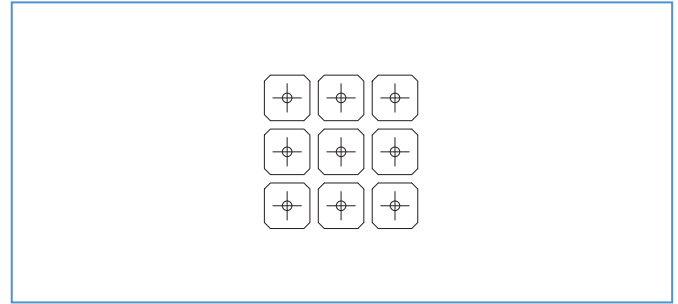

Figure 2:
Rounded square well design

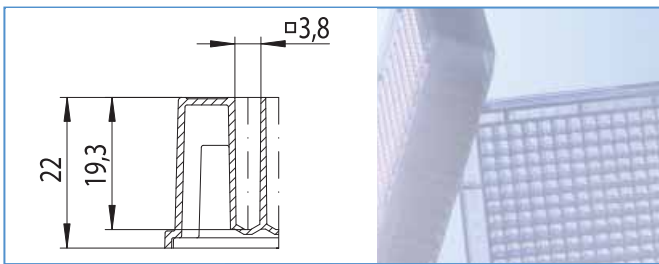

Figure 1:
Well profile: 384 Deep Well MASTERBLOCK®, polypropylene
Total volume: 240 µl
Working volume: 20 – 225 µl



384 Deep Well MASTERBLOCK®

▶ 384 Well Polypropylene Microplates p. 2 | 15

- Alphanumeric well coding
- High chemical resistance
- High temperature resistance (-196 °C to +121 °C)
- Sealable with adhesive films and heat sealer

Free of detectable
DNase, RNase,
human DNA
non-pyrogenic

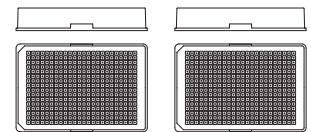

Cat.-No.	781 270	781 271
Well profile	V-bottom	V-bottom
Bottom	solid	solid
Colour	natural	natural
Binding	-	-
Sterile	-	+
Lid	-	-
Quantity per bag/case	6/60	6/60
Plate design	Deep Well	Deep Well

1536 Deep Well Polypropylene Microplates

The product range of the 1536 well polystyrene microplates is extended by a polypropylene storage plate (Deep Well microplate) with a total volume of 18 μ l. The working volume of this plate is between 3 and 15 μ l (Fig. 1).

- Uniform external dimensions and tolerances
- Alphanumeric well coding
- High chemical resistance
- High temperature resistance (-196 °C to +121 °C)
- Sealable with adhesive films and heat sealer

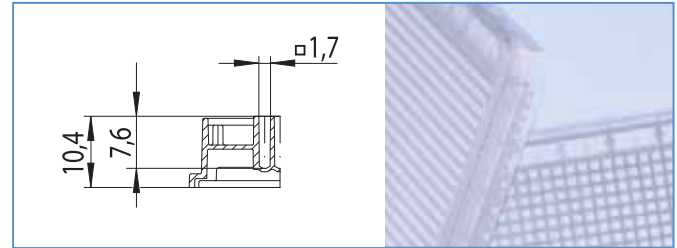
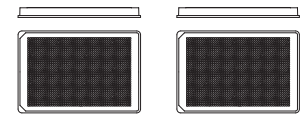

Figure 1:
Well profile: 1536 Deep Well Microplate, polypropylene
Total volume: 18 μ l
Working volume: 3 – 15 μ l



1536 Deep Well Polypropylene Microplates

Free of detectable
DNase, RNase,
human DNA
non-pyrogenic



Cat.-No.	782 261	782 270
Well profile	V-bottom	V-bottom
Bottom	solid	solid
Colour	natural	natural
Sterile	+	-
Lid	-	-
Quantity per bag/case	15/60	15/60
Plate design	Deep Well	Deep Well

Compound Storage Microplates

384 Well and 1536 Well Microplates for Compound Storage

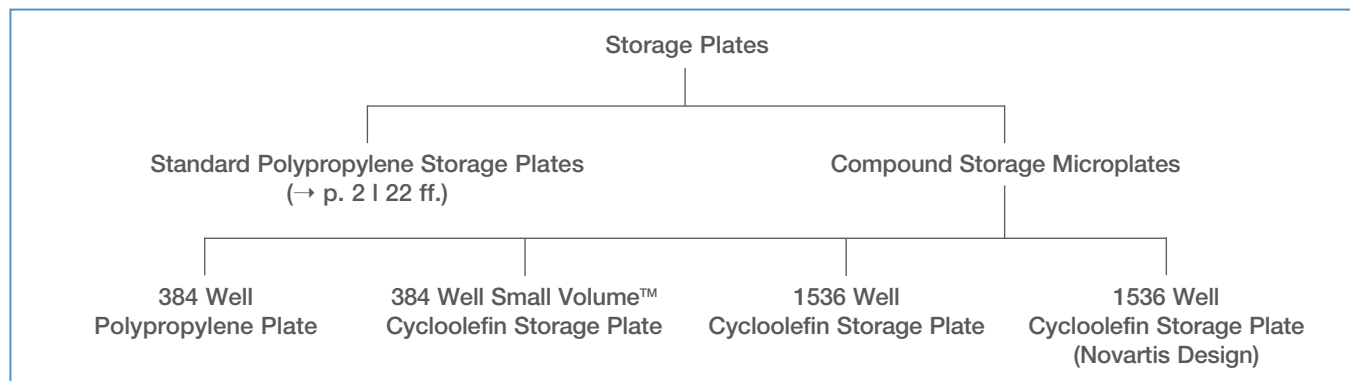

Polypropylene is still the material of choice for storage plates, but the material class of cycloolefins is becoming more routinely used because of its unsurpassed performance for a wide range of applications. In compound storage, plates made from cycloolefins offer the best combination of chemical resistance to polar solvents, like DMSO, and optical clarity. In addition, the dimensional stability and glass-like optical properties make this material ideally suited for plates in fully automated systems. (Detailed listing of the physical properties of cycloolefins → Technical Appendix).

Microplates made from cycloolefin offer the following advantages in compound storage:

- Resistant against polar solvents such as DMSO and alcohols
- Excellent water and vapour barrier function to minimise evaporation
- Nearly no extractables minimise leaching to avoid compound contamination
- Low biomolecule binding reduces the loss of compounds in storage and screening assays
- Glass-like optical properties for sensitive transmission and fluorescence measurements
- Superior mechanical stability and bottom thickness uniformity

384 Well Polypropylene Storage Plate

384 Well Small Volume™ Cycloolefin Storage Plate

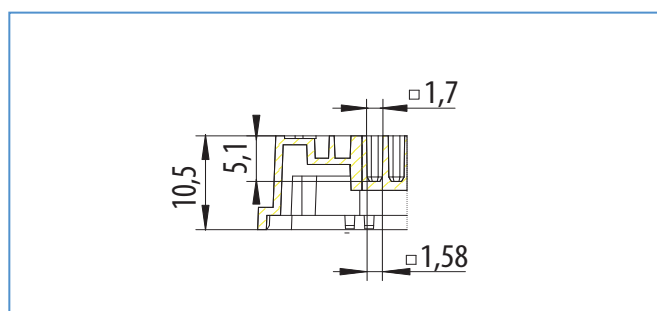
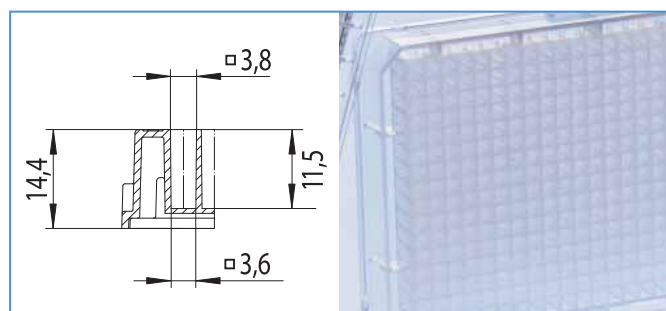

Figure 1:
 Well profile: 384 well polypropylene storage plate
 Total volume: 152 µl
 Working volume: 15 – 145 µl

Figure 2:
 Well profile: 384 well Small Volume™ cycloolefin storage plate

The 384 well polypropylene microplates are the classic storage plates. They can be easily sealed using commercially available heat-sealers and bind negligible amounts of proteins or active substances (Fig. 1).

The new 384 well Small Volume™ cycloolefin microplate reduces the dead volume in compound storage. (Fig. 2).

1536 Well Cycloolefin Storage Plate

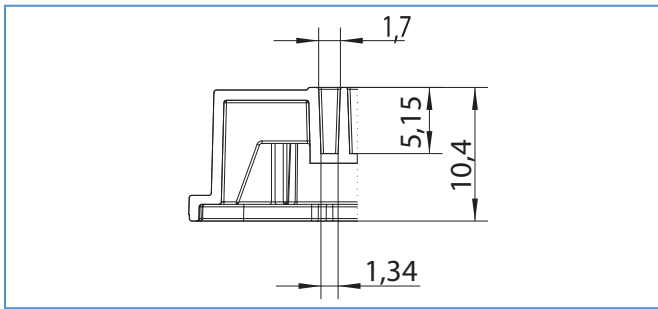

Figure 3:
Well profile: 1536 well cycloolefin storage plate
Total volume: 12 µl
Working volume: 1 – 10 µl

The new 1536 well cycloolefin storage plate allows the storage of non-human sample material in the 1536 well format and reduces the dead volume in compound storage. With a working volume of 1 - 10 µl this microplate is ideal for working with minimal sample volumes (Fig. 3).

1536 Well Cycloolefin Storage Plate with Optimised Geometry for Low Evaporation

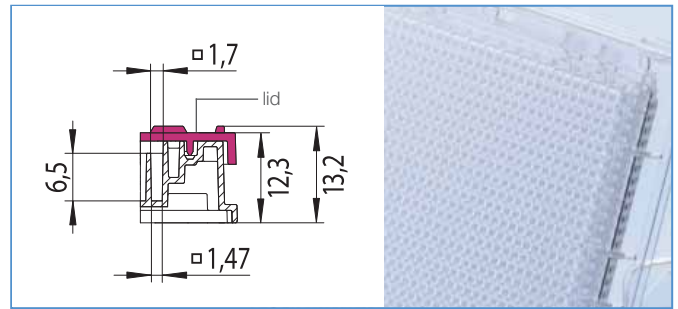

Figure 4:
Well profile: 1536 well cycloolefin storage plate with optimised geometry and lid
Total volume: 16 µl
Working volume: 1 – 14 µl

The 1536 well cycloolefin storage plate with optimised geometry was developed in collaboration with Novartis AG, Basel, CH. The microplate features a continuous groove around the edges of the plate, in which a matching cycloolefin plate lid fits (Fig. 4). This prevents evaporation and minimises edge effects.



384 and 1536 Well Storage Plates for Compound Storage

- Stringent production specifications for a constant bottom quality
- Microplates are deionised and packed in antistatic bags

Free of detectable DNase, RNase, human DNA
non-pyrogenic

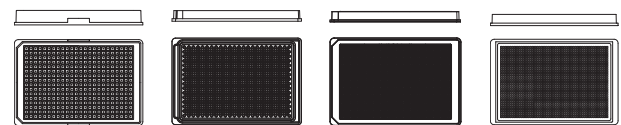

Cat.-No.	781 201-906	793 855	782 855	792 870-906
Well format	384 well	384 well	1536 well	1536 well
Well profile	F-bottom	Small Volume™	F-bottom	F-bottom
Material	polypropylene	cycloolefin	cycloolefin	cycloolefin
Bottom	solid	solid	solid	solid
Colour	natural	clear	clear	clear
Sterile	-	-	-	-
Lid	-	-	-	Cat.-No. 792 891
Quantity per bag/case	10/100	15/60	15/60	15/60

▶ New

▶ New

Non-binding Microplates

Microplates with Non-Binding Surface Properties for Biochemical Assays

High quality microplates with well-defined properties are essential prerequisites for reproducible results in advanced drug discovery. In addition to format and pigmentation, determining the best microplate surface for use within a specific application is a critical factor for successful high-throughput screening.

Polystyrene microplates with medium binding surfaces are commonly used for homogeneous biochemical HTS assays. Manufactured of carefully selected raw material batches, medium binding microplates demonstrate low reproducible biomolecule binding. As medium binding microplate surfaces are not physically modified, their surface characteristics are representative of pure polystyrene.

However, even low amounts of biomolecular binding (e.g. DNA, RNA, proteins, peptides) can cause an undesirable increase in background, resulting in decreased signal-to-noise ratio. Greiner Bio-One's non-binding microplate surfaces prevent unwanted non-specific binding, especially advantageous for sensitive biochemical assays.

Characterised by low protein, DNA, RNA and peptide binding properties (Fig. 1, Fig. 2) the new non-binding surfaces significantly increase assay sensitivity by reducing background and improving signal-to-noise ratio (Fig. 3).

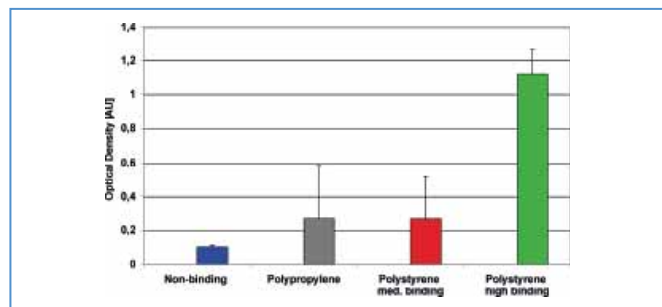

Figure 1: Peptide binding (5.8 kDa) on different surfaces

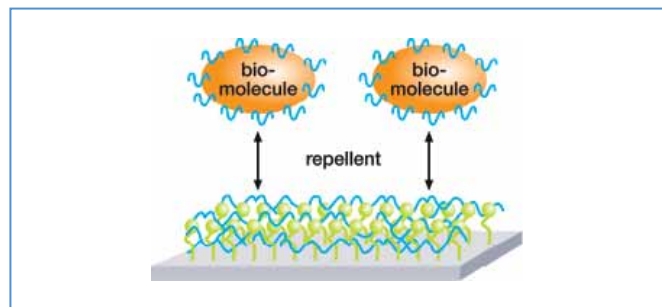

Figure 2: Technology of the non-binding surface. The hydrate layer, created by covalently linked functional groups, enables biomolecules to remain in solution, thereby preventing their binding to the surface.

Non-binding surfaces from Greiner Bio-One are achieved through a stable chemical modification to covalently link functional groups with the base polystyrene polymer. Under aqueous assay conditions a hydrate layer forms, preventing dissolved biomolecules from binding to the microplate surface (Fig. 2). As the non-binding surface is stable under common assay conditions (Fig. 4), there is no potential for degradation or leaching and resultant assay interference.

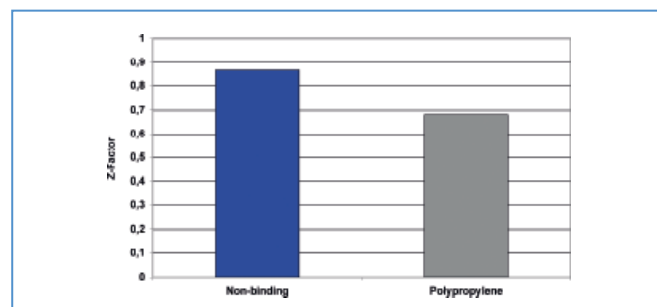

Figure 3: Z-factor of a biochemical assay (Perkin Elmer TruPoint™ Caspase-6 assay). Comparison of non-binding versus polypropylene microplates. (The z-factor defines the precision of an assay; a factor of 1 represents the highest precision possible.) [1]

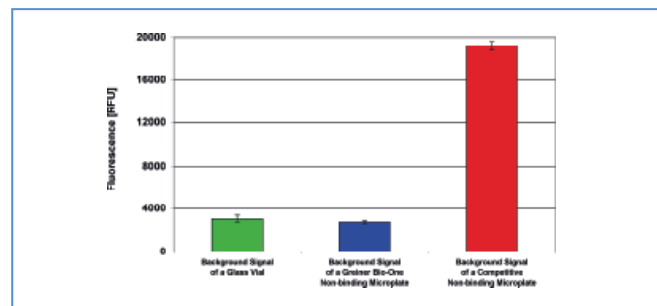

Figure 4: Background signal using Quanti-iT™ Protein Detection Kit from Molecular Probes (Cat.-No. Q33210). The dye of the Quanti-iT™ kit stains proteins as well as detergents. In the absence of protein, a high fluorescence signal indicates the presence of high amounts of dissolved detergents that have leached from the vessel surface.

Non-binding microplates are featured in 96, 384 and 1536 well formats in black, white and clear, including solid and µClear® film well bottoms.

- Characteristic features of the non-binding surface are:
- Ultra low non-specific biomolecular binding properties (proteins, DNA, RNA)
 - Long-term surface stability without degradation or leaching
 - Higher assay sensitivity with reduced background

[1] Zhang et al.: Journal of Biomolecular Screening, Vol. 4 No. 2 (1999); 67-73



96 Well Non-binding Microplates

↳ 96 Well Med. Binding and High Binding Microplates p. 2 | 8

Free of detectable DNase, RNase, human DNA non-pyrogenic

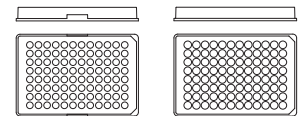

Cat.-No.	650 901	651 901
Well format	96 well	96 well
Well profile	U-bottom	V-bottom
Bottom	solid	solid
Colour	clear	clear
Binding	non-binding	non-binding
Sterile	-	-
Lid	-	-
Quantity per bag/case	10/40	10/40

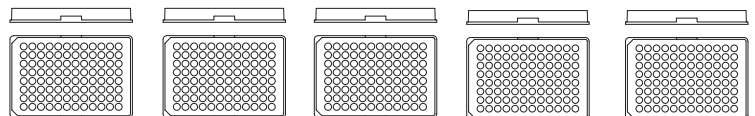

Cat.-No.	655 901	655 904	655 900	655 903	655 906
Well format	96 well	96 well	96 well	96 well	96 well
Well profile	F-bottom/ chimney well	F-bottom/ chimney well	F-bottom/ chimney well	F-bottom/ chimney well	F-bottom/ chimney well
Bottom	solid	solid	solid	µClear®	µClear®
Colour	clear	white	black	white	black
Binding	non-binding	non-binding	non-binding	non-binding	non-binding
Sterile	-	-	-	-	-
Lid	-	-	-	-	-
Quantity per bag/case	10/40	10/40	10/40	10/40	10/40

1 Cell/ Tissue Culture
 2 HTS- Microplates
 3 Immunology/ HLA
 4 Microbiology/ Bacteriology
 5 Tubes/Multi- Purpose Beakers
 6 Liquid Handling
 7 Molecular Biology
 8 Protein Crystallisation
 9 Separation
 10 Biochips/ Microfluidics
 11 Cryo- Technics
 12 Lids/Sealers/ CapMats
 13 Reaction Tubes/ Analyser Cups
 14 Accessories

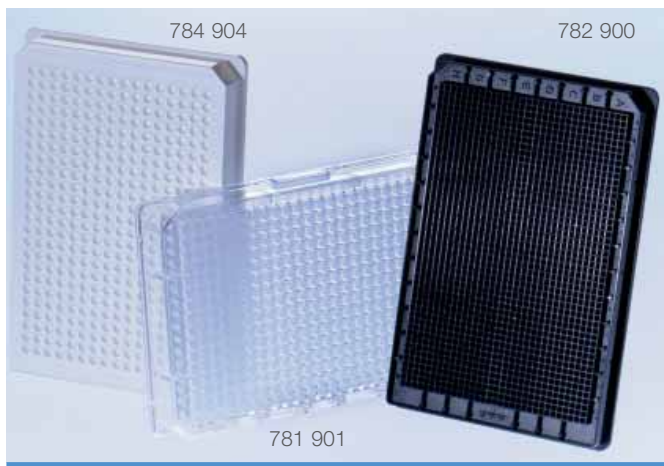

384, 1536 Well Non-binding Microplates

384 Well Med. Binding and High Binding Microplates p. 2 | 13 f.
 1536 Well Med. Binding and High Binding Microplates p. 2 | 20 f.

Free of detectable DNase, RNase, human DNA non-pyrogenic

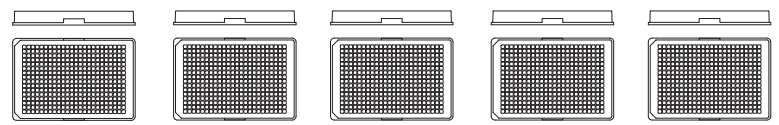

Cat.-No.	781 901	781 904	781 900	781 903	781 906
Well format	384 well	384 well	384 well	384 well	384 well
Well profile	F-bottom	F-bottom	F-bottom	F-bottom	F-bottom
Bottom	solid	solid	solid	µClear®	µClear®
Colour	clear	white	black	white	black
Binding	non-binding	non-binding	non-binding	non-binding	non-binding
Sterile	-	-	-	-	-
Lid	-	-	-	-	-
Quantity per bag/case	10/40	10/40	10/40	10/40	10/40

New

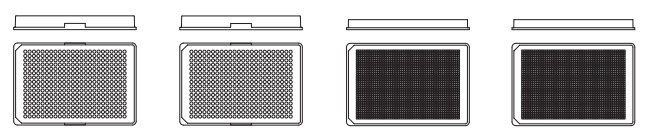

Cat.-No.	784 904	784 900	782 904	782 900
Well format	384 well	384 well	1536 well	1536 well
Well profile	Small Volume™	Small Volume™	F-bottom	F-bottom
Bottom	solid	solid	solid	solid
Colour	white	black	white	black
Binding	non-binding	non-binding	non-binding	non-binding
Sterile	-	-	-	-
Lid	-	-	-	-
Quantity per bag/case	10/40	10/40	15/60	15/60
Plate design	HiBase	HiBase	HiBase	HiBase

New

New

Streptavidin-coated Microplates

Streptavidin-coated solid phases serve as reliable binding surfaces for all types of biotinylated molecules. Numerous ligands can be biotinylated simply and due to the low molecular weight of biotin (244 Da) the functionality of the molecules is normally not impaired.

Thus streptavidin-coated solid phases make it possible to rapidly isolate, determine and quantify components from a reaction mixture. By immobilising the biotinylated substance, it is also possible to reproduce complete reaction chains on a streptavidin solid phase, e.g. enzyme immunoassays, enzyme activity assays, DNA hybridisation techniques, quantification of PCR products and receptor/ligand studies. The high-purity streptavidin is bound to the plate surface in a uniform and stable layer.

The coefficient of variation from well to well is under 5 % for 96 well microplates and under 8 % for 384 microplates.

The streptavidin solid phase is treated with an additional blocking step in order to minimise any unspecific binding, therefore, „pre-blocking“ of plates is not necessary. The high stability of the coating and the high affinity between streptavidin and biotin enables unusually stringent washing conditions, which have a positive effect on the signal-to-noise ratio of the measurement.

- Shelf-life: 3 years at room temperature
- Pre-blocking: All plates are pre-blocked and ready-to-use

	96 Well Microplate	384 Well Microplate
Streptavidin-coating (in relation to volume)	300 µl	90 µl
Biotin binding capacity ^{*)}	> 5 ng/well or > 20 pmol/well	> 1.5 ng/well or > 6 pmol/well

^{*)} Biotin binding capacity determined by competition test

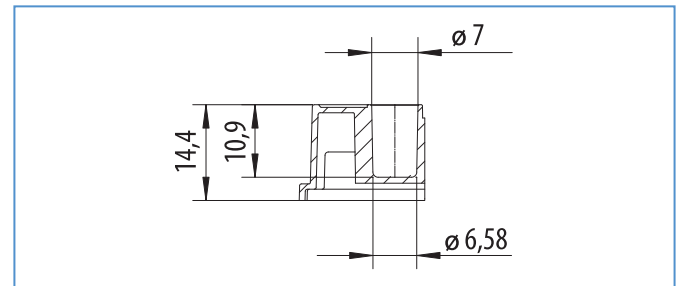
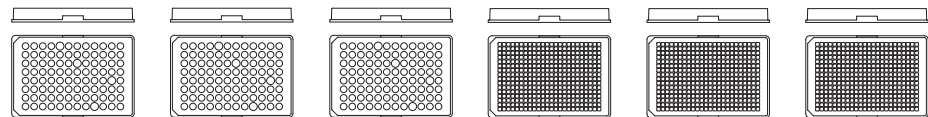

Figure 1:
Well profile: 96 well, C-bottom, polystyrene



96, 384 Well Streptavidin-coated Microplates solid bottom, clear / white / black

- Further streptavidin-coated microplates are available on request



Cat.-No.	655 990	655 995	655 997	781 990	781 995	781 997
Well format	96 well	96 well	96 well	384 well	384 well	384 well
Well profile	C-bottom	C-bottom	C-bottom	F-bottom	F-bottom	F-bottom
Bottom	solid	solid	solid	solid	solid	solid
Colour	clear	white	black	clear	white	black
Streptavidin-coating	+	+	+	+	+	+
Sterile	-	-	-	-	-	-
Lid	-	-	-	-	-	-
Quantity per bag/case	5/40	5/40	5/40	5/40	5/40	5/40

SensoPlate™

Glass Bottom Microplates

The research of biomolecular processes on the level of single molecules and in volume ranges equivalent to the size of a single bacterium is of immense importance, both in basic research and in industrial high-throughput screening. The combination of modern confocal optics, new fluorescent dyes, sensitive photomultipliers and improved data processing has revolutionised the technique of fluorescence correlation spectroscopy (FCS) (Fig. 1). Over the past few years this has led to its widespread application, and alongside the technological advances in hardware development, Greiner Bio-One worked hand-in-hand with customers and instrument suppliers to develop the glass bottom microplates. These better satisfy the requirements of fluorescence correlation spectroscopy with regard to optical clarity and deformation when compared to standard polystyrene plates.

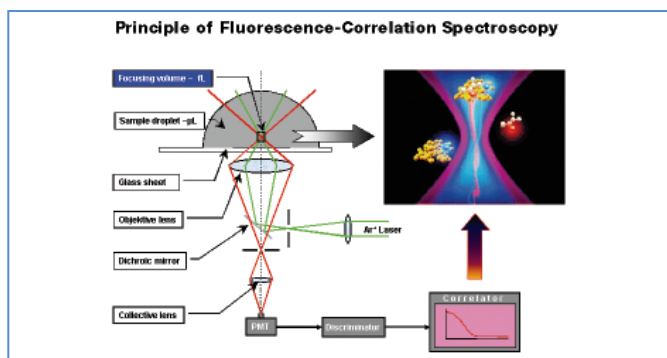

Figure 1:
The principles of fluorescence correlation spectroscopy

The **SensoPlate™** family was developed in a complete product line consisting of 24, 96, 384 and 1536 well glass bottom formats. All plates consist of an optically clear borosilicate glass bottom with a light path of 175 +/- 15 µm and a black polystyrene frame. The glass bottom allows transmission measurements in the wavelength range above 350 nm. For mounting the glass bottom plates an adhesive with the lowest possible autofluorescence is used.

In addition to fluorescence correlation spectroscopy, microscopic applications such as confocal microscopy are a potential area of application for glass bottom microplates. The 175 µm thick glass bottom of the **SensoPlate™** is equivalent to the light path of standard coverslips. The **SensoPlate™** family is available sterile with lid but should be tested for their suitability for cell culture before application. For sensitive or transformed cell lines pre-coating with an extracellular matrix such as Poly-Lysine or Collagen is recommended. 4 % formaldehyde is recommended for fixing cells.

The footprint of all glass bottom microplates is conform to the ANSI 1-2004 standard (Fig. 2). For further information please visit our website: www.gbo.com/bioscience/technical_information.

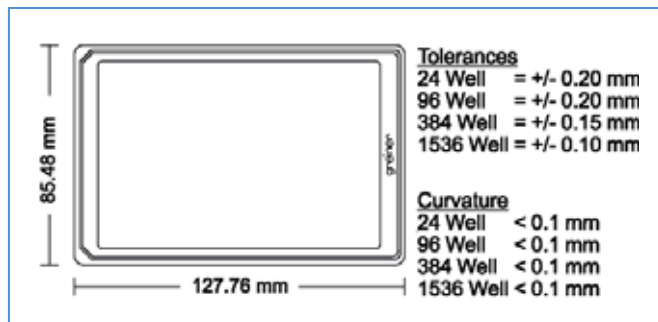

Figure 2:
Footprint and tolerances of SensoPlate™ and SensoPlate™ Plus

In-process-controls and constant quality monitoring ensures minimum surface deformation (< 0.1 mm).

The **SensoPlate™ Plus** glass bottom microplates were developed in collaboration with Evotec Technologies GmbH for optical applications in High-Content Screening. They are characterised by an improved geometry, which enables interference-free measurements and also microscopy over the whole surface of the bottom of a microplate (Fig. 3 and 4). The short distance of 0.3 mm between the external well bottom (underside) and microplate skirt bottom facilitates changing objectives during microscopy and imaging perimeter wells without hindrance. The **SensoPlate™ Plus** is available non-sterile without lid in 384 well and 1536 well format.

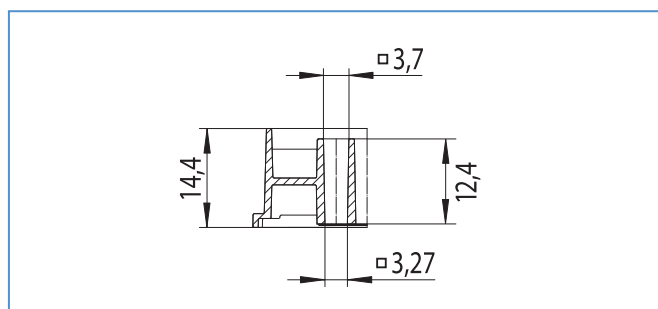

Figure 3:
Well profile: 384 well SensoPlate™ Plus
Total volume: 145 µl
Working volume: 10 – 130 µl

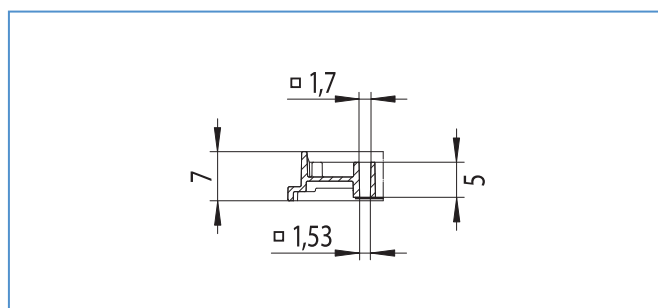
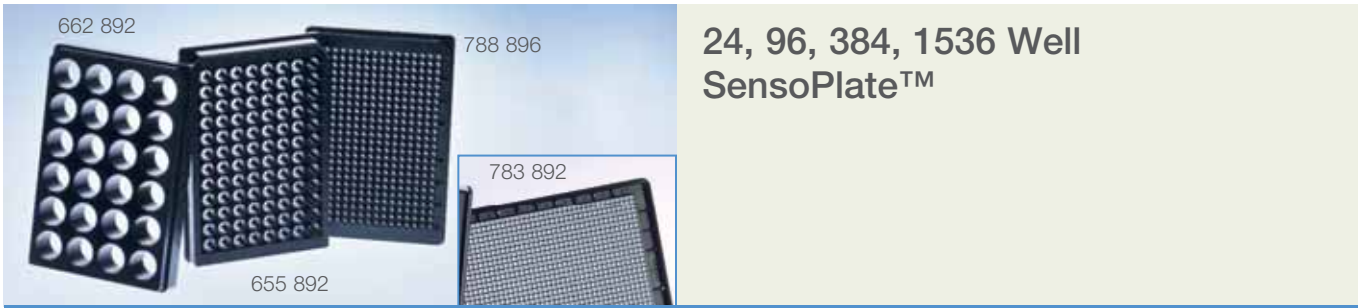
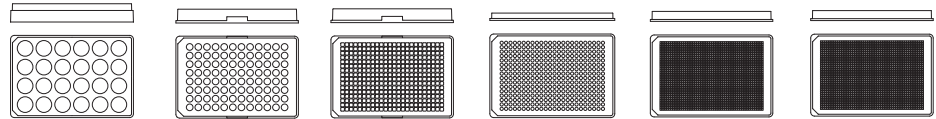

Figure 4:
Well profile: 1536 well SensoPlate™ Plus
Total volume: 13 µl
Working volume: 3 – 10 µl

SensoPlate™ and SensoPlate™ Plus



24, 96, 384, 1536 Well SensoPlate™



Cat.-No.	662 892	655 892	781 892	788 896	782 892	783 892
Well format	24 well	96 well	384 well	384 well	1536 well	1536 well
Well profile	F-bottom	F-bottom	F-bottom	Small Volume™	F-bottom	F-bottom
Bottom	glass	glass	glass	glass	glass	glass
Colour	black	black	black	black	black	black
Sterile	+	+	+	+	+	+
Lid	+	+	+	-	+	+
Quantity per bag/case	1/12	1/16	1/16	1/16	1/16	1/16
Plate design				LoBase	HiBase	LoBase



384, 1536 Well SensoPlate™ Plus

- For High-Content Screening applications
- Developed in collaboration with Evotec Technologies GmbH

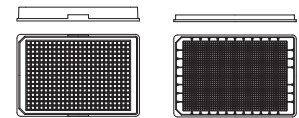

Cat.-No.	781 856	783 856
Well format	384 well	1536 well
Well profile	F-bottom	F-bottom
Bottom	glass	glass
Colour	black	black
Sterile	-	-
Lid	-	-
Quantity per bag/case	1/16	4/16
Plate design	extra LoBase	extra LoBase

UV-Star® Microplates

UV/VIS spectroscopy is a classical analytical method for determining the chemical constitution of a substance and its concentration in aqueous solution. UV/VIS spectroscopy is usually conducted in quartz glass cuvettes. However, cuvettes do not provide sufficient throughput when dealing with large amounts of samples, and microplates can be used to speed up work.

Standard polystyrene microplates are only partially suitable for transmission measurements in the UV. Polystyrene absorbs UV especially in the short-wavelength range (< 320 nm). µClear® microplates with a thin polystyrene film base already have much lower background values and can be used up to 340 nm without any problem. The adaptation of the patented µClear® process technology to a new, innovative UV-transparent material has made it possible to produce microplates that extend the transmission range up to 230 nm (Fig. 1).

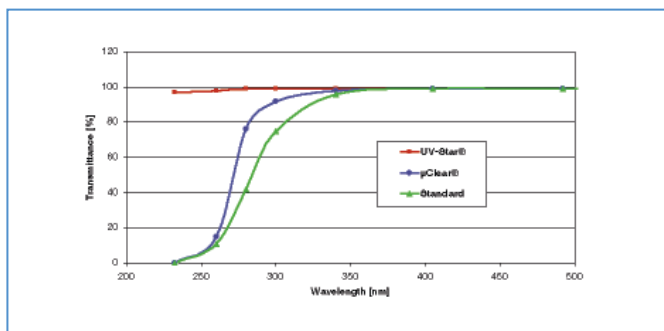

Figure 1: Light transmission of UV-Star® and µClear® microplates compared with a conventional microplate

For the determination of nucleic acid and protein concentrations at 260 nm or 280 nm without background interference UV-Star® microplates are the ideal alternative to expensive and fragile quartz glass plates or cuvettes. UV-Star® plates are also DMSO-resistant and can be stored at -20 °C without any problem.

In accordance with Lambert Beer's Law, the amount of absorbed light in a sample is proportional to the concentration and layer thickness (i.e. pathlength) of the substance to be measured (Fig. 2).

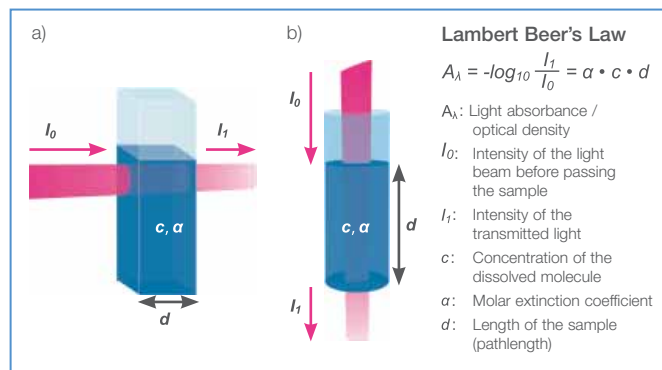

Figure 2: Lambert Beer's Law. Fixed pathlength in a cuvette (a) compared to a variable pathlength in a microplate well (b).

In classical spectral photometry with quartz glass cuvettes, measurement is made horizontally with a set pathlength of usually 1 cm. Given a known coefficient of extinction and a standardised distance of travel, the concentration of a substance can be determined without standards, although a large amount of sample is required to completely fill a cuvette.

After measurement, the sample measured is only of limited further use as a result of the risk of contamination. In the case of concentration determinations in microplates, the measurement is made vertically and the layer thickness of the sample to be measured is dependent on the sample volume (Fig. 2). Even with smaller sample volumes, the resulting layer thicknesses are sufficient for precise measurement. At a constant sample volume, concentrations can be determined with the aid of a calibration curve. In the case of a varying sample volume, the layer thickness can either be calculated mathematically (→ Technical Appendix) or determined optically taking into account the absorption of water in the infrared range [1].

[1] Rieger, A., Hale, P.D.: Übertragung spektralphotometrischer Daten von Küvetten auf Microplatten [Transmission of spectral photometric data from cuvettes to microplates]. LaborPraxis, 05 (2002): 72 – 76

! Further information on UV/VIS spectroscopy
 → **Application Note "UV/VIS Spectroscopy"**
 (F073 041)

Well Profile

Well profile of a standard 96 and 384 well UV-Star® microplate (Fig. 3 and Fig. 4) and well profile of 96 well half area UV-Star® microplate (Fig. 5):

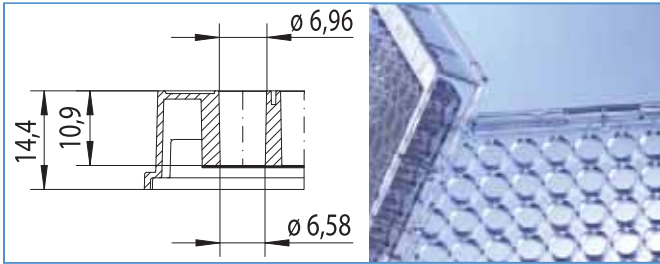

Figure 3:
Well profile: 96 well UV-Star® microplate
Total volume: 392 µl
Working volume: 25 – 340 µl

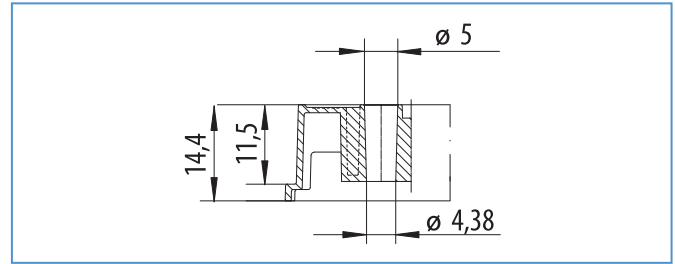

Figure 5:
Well profile: 96 well half area UV-Star® microplate
Total volume: 199 µl
Working volume: 15 – 175 µl
Standardised pathlength (1 cm = 170 µl, 0.5 cm = 80 µl)

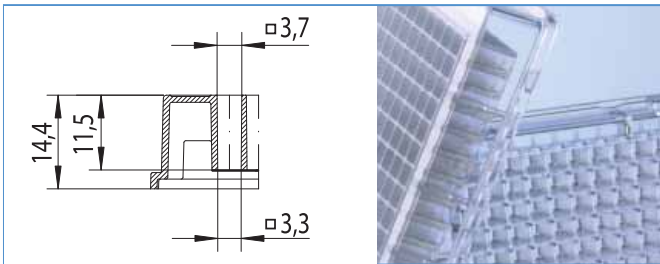

Figure 4:
Well profile: 384 well UV-Star® microplate
Total volume: 131 µl
Working volume: 15 – 110 µl

96, 384 Well UV-Star® Microplates



96, 384 Well UV-Star® Microplates

- Optical window down to 230 nm ideal for nucleic acid determinations at 260 nm/280 nm
- For measurements of protein concentration at 280 nm

Free of detectable
DNase, RNase,
human DNA
non-pyrogenic

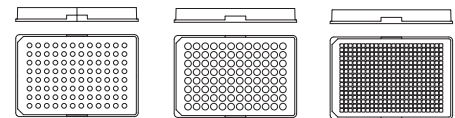

Cat.-No.	675 801	655 801	781 801
Well format	96 well	96 well	384 well
Well profile	half area	F-bottom/ chimney well	F-bottom
Bottom	µClear®	µClear®	µClear®
Colour	clear	clear	clear
Sterile	-	-	-
Lid	-	-	-
Quantity per bag/case	10/40	10/40	10/40