



Immunology

ELISA (Enzyme-Linked Immunosorbent Assay) is probably the most widely used biochemical method in laboratory analysis and diagnostics. Analytes such as peptides, proteins, antibodies and hormones can be detected selectively in low concentrations among a multitude of other substances and be quantified. Additionally, ELISAs are rapid, sensitive, cost-effective and can be performed in a high-throughput manner.

ELISA is used in a variety of different assay types (e.g. direct ELISA, indirect ELISA, sandwich ELISA, competitive ELISA). Nevertheless, all ELISA variants are based on the same principle, the binding of one assay component – antigen or specific antibody – to a solid surface and the selective interaction between both assay components. Molecules not specifically interacting with the assay component bound to the solid surface are washed away during the assay.

For detection of the interaction the antibody or antigen is labelled or linked to an enzyme (direct ELISA; Fig. 1). Alternatively, a secondary antibody conjugate can be used (indirect ELISA; Fig. 2). The assay is processed by adding an enzymatic substrate to produce a measurable signal (colorimetric, fluorescent or luminescent). The strength of the signal indicates the quantity of analytes in the sample.

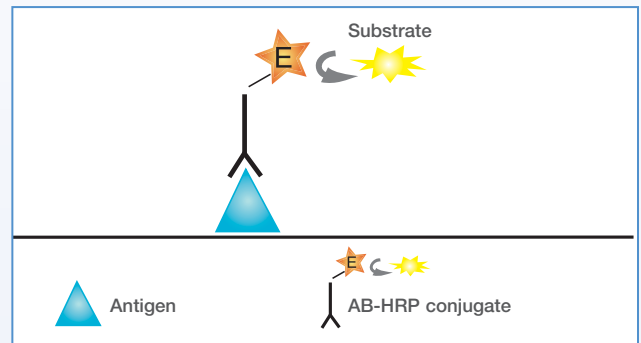

Figure 1: Direct ELISA

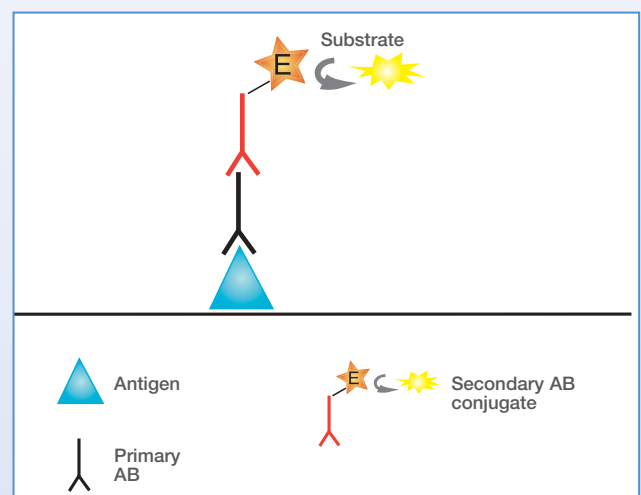

Figure 2: Indirect ELISA

! Further information on ELISA

- **Forum No. 9: Microplates for enzyme-linked immunosorbent assays (ELISA) (F073 004)**
- **Application Note “Insulin ELISA on high binding MICROLON® 600 and CELLSTAR® microplates” (F073 106)**
- **Application Note “Influence of coating buffer and incubation conditions on ELISA performance” (F073 118)**

Surface Properties and Microplate Colour

A key step in ELISA is the binding of one assay component – antigen or antibody – to the solid surface by passive adsorption. Therefore, the features of this surface are crucial for the performance of the assay. All ELISA microplates from Greiner Bio-One are made out of high-quality virgin polystyrene. The resin is highly transparent and therefore ideally suited for optical measurements. Due to its chemical nature polystyrene is a hydrophobic compound. Hydrophilic groups can be introduced to polystyrene surfaces by physical treatment. Greiner Bio-One offers two surface qualities for ELISA microplates: the hydrophilic **high binding** products and the less hydrophilic **medium binding** products.

Since attachment to a solid surface based upon passive adsorption depends as well on the properties of the molecule to be bound, it is therefore advisable to compare the performance of high binding and medium binding products when developing a new assay.

Beside products made of clear polystyrene for colorimetric measurements, Greiner Bio-One offers a wide variety of black and white ELISA microplates for luminescence and fluorescence measurements. Colour and surface properties can be deduced from the respective brand name of our products (Table 1).

Brand name	Surface property	Colour
MICROLON® 200	Medium binding	clear
MICROLON® 600	High binding	clear
FLUOTRAC™ 200	Medium binding	black
FLUOTRAC™ 600	High binding	black
LUMITRAC™ 200	Medium binding	white
LUMITRAC™ 600	High binding	white

Table 1: Assignment of brand names and properties of ELISA microplates

Quality aspects

We set high standards on the quality of our immunological products, especially on consistency and reproducibility of binding properties. As the raw material has a major influence on the binding properties of the final product, the incoming raw material used for ELISA microplates is routinely monitored for identity and immunological quality. Sample plates are tested with an immunoassay (ELISA, LIA or FIA, depending on their applications) and must fulfil the following criteria:

- For intra-plate homogeneity the coefficient of variation (CV) must not exceed 5 % for colorimetric or 10 % for fluorescence and luminescence assays.
- For all immunological products, to provide constant binding properties, the CV for five tested plates must not exceed 10 %. Additionally, the ratio of new sample plates to reference plates has to be in the range of 100 +/-10 %.

The main criterion for our ELISA microplates is a stable coefficient of variation (CV) from batch to batch which is monitored over a long period (Fig. 3).

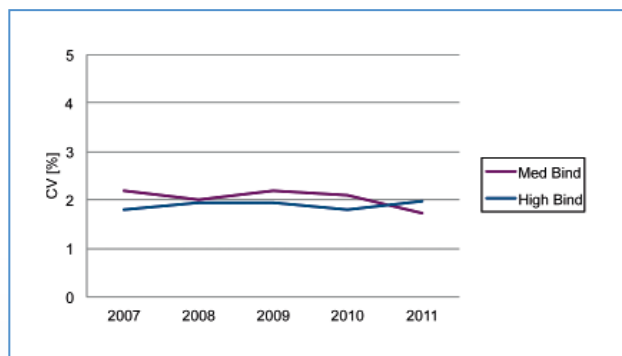

Figure 3: Coefficient of variation (CV) of tested raw material batches from 2007 to 2011 for transparent microplates (med. and high binding)

If the criteria have been met, the raw material batch is approved and released for the production of ELISA microplates.

This raw material batch is also documented on the package labelling of the end product. The package labelling of our ELISA microplates is as follows:

The number of the raw material batch used can be found on the package box, alongside the shelf life, the lot number, a consecutive box number and an in-process control number (Fig. 4).

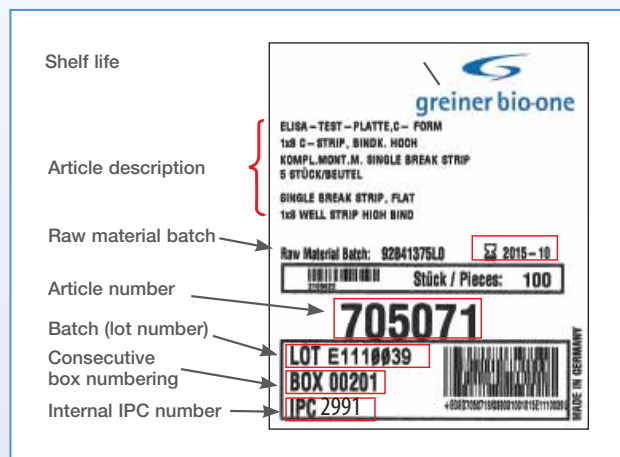

Figure 4: Package labelling of immunological products

96 Well ELISA Microplates

Greiner Bio-One has been manufacturing microplates for diagnostics and immunological research for over 30 years. A wide variety of microplates with different surface treatments is available. The spectrum ranges from clear bottom microplates and completely black or white microplates to UV-Star® products. The microplate footprint is compatible with automated systems.

! Further information on immunological 96 well microplates (FLUOTRAC™ and LUMITRAC™ microplates) and higher format immunological microplates (384 and 1536 well microplates) → chapter 2 p. 2 | 4, 2 | 12 ff., 2 | 19 ff.

Well Profile

The well profile is a key feature in a 96 well microplate. Five different well profiles are available:

1. U-Bottom (Fig. 1)

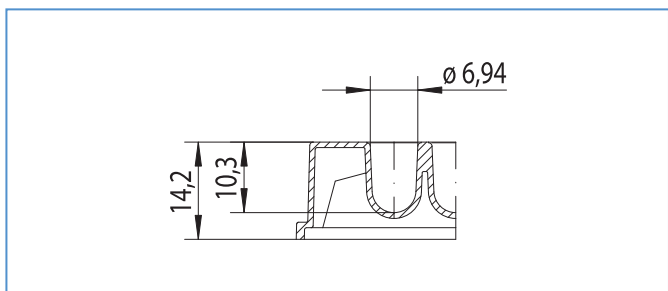

Figure 1:
 Well profile: U-bottom
 Total volume: 323 µl
 Working volume: 40 - 280 µl

2. V-Bottom (Fig. 2)

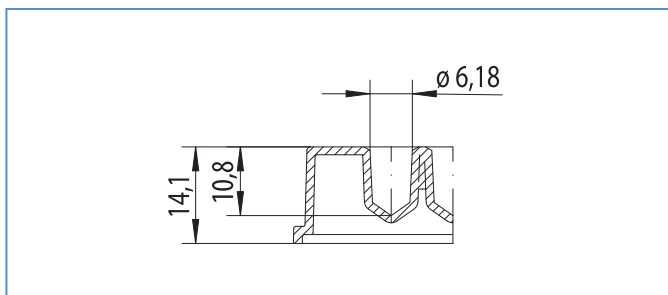

Figure 2:
 Well profile: V-bottom
 Total volume: 234 µl
 Working volume: 40 - 200 µl

3. F-Bottom / Standard (ST) (Fig. 3)

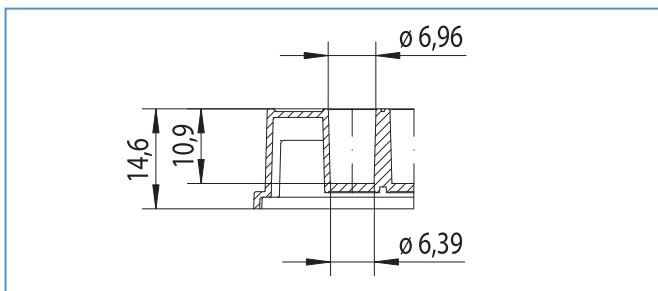

Figure 3:
 Well profile: F-bottom / ST
 Total volume: 382 µl
 Working volume: 25 - 340 µl

4. F-Bottom / Chimney Well (Fig. 4)

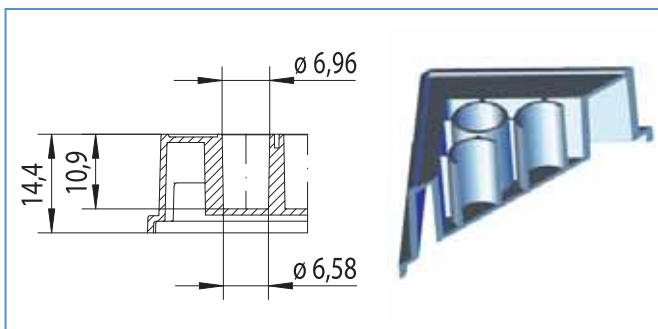

Figure 4:
 Well profile: F-bottom / chimney well
 Total volume: 392 µl
 Working volume: 25 - 340 µl

5. Half Area (Fig. 5)

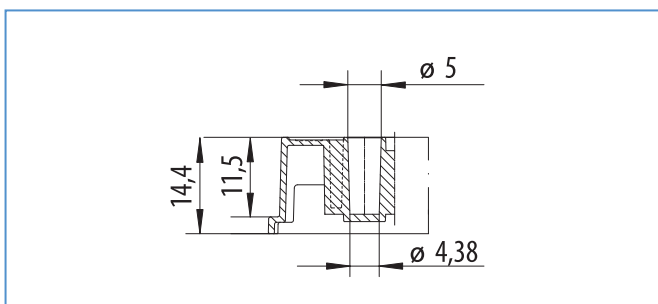
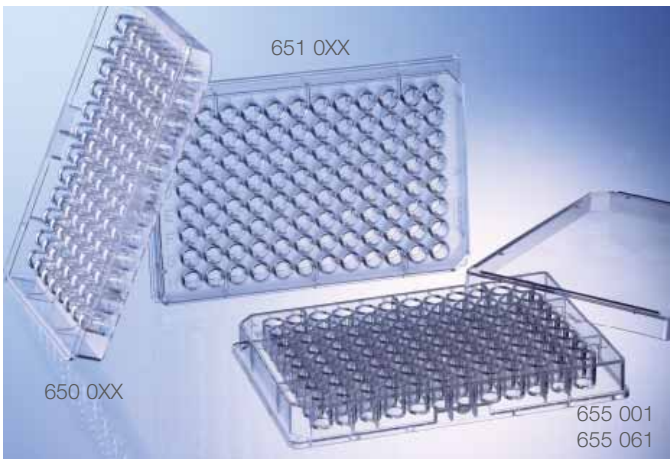

Figure 5:
 Well profile: Half area
 Total volume: 199 µl
 Working volume: 15 - 175 µl

Further information on well profiles → p. 2 | 6.

! Detailed information about wetted surface and surface/volume ratios → Technical Appendix p. A | 21 f.



96 Well ELISA Microplates U-Bottom / V-Bottom / F-Bottom Half Area

- Manufactured from crystal clear polystyrene

Free of detectable
DNase, RNase,
human DNA
non-pyrogenic

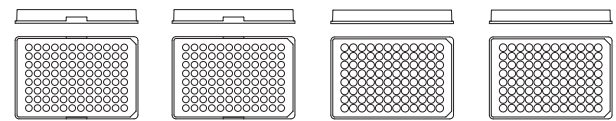

Cat.-No.	650 001	650 061	651 001	651 061
Well format	96 well	96 well	96 well	96 well
Well profile	U-bottom	U-bottom	V-bottom	V-bottom
Binding	MICROLON® 200 med. binding	MICROLON® 600 high binding	MICROLON® 200 med. binding	MICROLON® 600 high binding
Colour	clear	clear	clear	clear
Lid	-	-	-	-
Quantity per bag/case	5/40	5/40	5/40	5/40

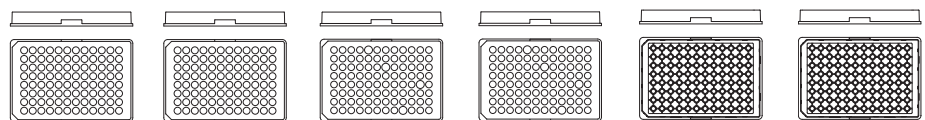

Cat.-No.	655 001	655 061	655 080	655 081	675 001	675 061
Well format	96 well	96 well	96 well	96 well	96 well	96 well
Well profile	F-bottom / ST	F-bottom / ST	F-bottom / chimney well	F-bottom / chimney well	half area	half area
Binding	MICROLON® 200 med. binding	MICROLON® 600 high binding	MICROLON® 200 med. binding	MICROLON® 600 high binding	MICROLON® 200 med. binding	MICROLON® 600 high binding
Colour	clear	clear	clear	clear	clear	clear
Lid	-	-	-	-	-	-
Quantity per bag/case	5/40	5/40	5/40	5/40	10/40	10/40

96 Well ELISA Strip Plates

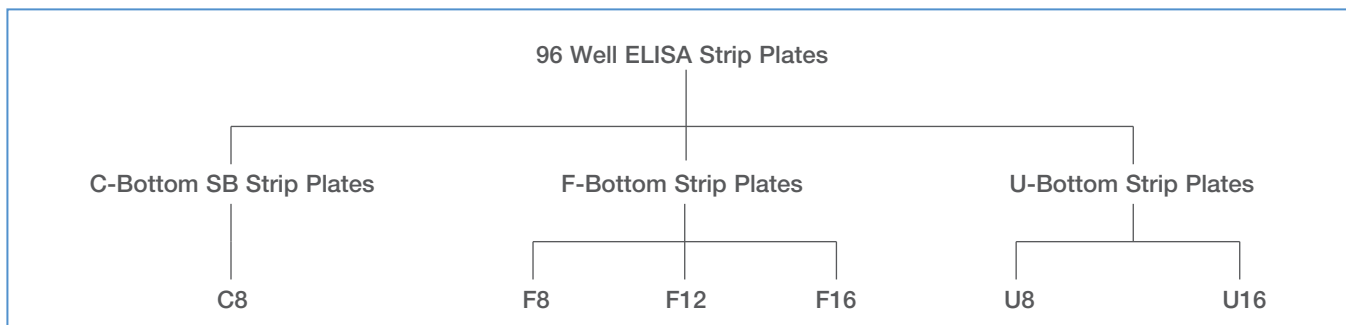

Figure 1:
Overview of the microplates available in strip format

Microplates in strip format offer the advantage of greater flexibility in diagnostics. Individual strips can be removed from the support frame so that the number of tests to be performed can be adjusted to the number of samples, and is not predetermined by the microplate format used. In addition, the individual strips of a microplate can be subjected to a wide variety of different test conditions. An overview of the available microplates in strip format is provided in Fig. 1.

Well Profile



Detailed information about wetted surface and surface/volume ratios
→ Technical Appendix p. A | 21 f.

1. C-Bottom SB (Single-break) Strip Plates

The “C” describes a flat-bottom profile with rounded corners (Fig. 2). The rounded corners mean that the individual wells can be pipetted without leaving a residue, and the flat bottom still enables precise optical measurements. C-bottom SB strips are supplied as twelve 8 well strips, in a support frame with 96 spaces (12 x 8 matrix). The individual wells can be broken off separately (“single-break” option) and the number of tests performed can thus be precisely adjusted to the number of samples. C-bottom SB strip plates are available in clear polystyrene and additionally with a red, green, blue or yellow colour coding on the well rim.

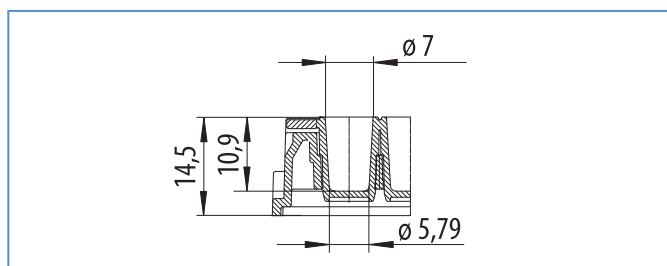

Figure 2:
Well profile: C-bottom
Total volume: 346 μ l
Working volume: 20 - 300 μ l

2. U-Bottom Strip Plates

96 well strip plates with a round bottom (U-bottom, Fig. 3) are available as both 8 well and 16 well strips. The “U” describes the round bottom form. U-bottom strip plates are ideally suited for agglutination tests.

- No corners, therefore simple and clean pipetting
- Suitable for +/- analyses

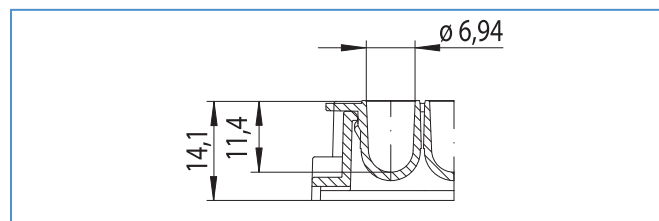

Figure 3:
Well profile: U-bottom
Total volume: 312 μ l
Working volume: 50 - 280 μ l

3. F-Bottom Strip Plates

96 well strip plates with a flat bottom (F-bottom, Fig. 4) are available

- as 8 well strips
- as 12 well strips
- as 16 well strips

The “F” stands for the flat bottom of the wells. This well type is ideal for the most precise optical measurements as the measuring light beam is not deflected by the well profile. F-bottom strip plates are available in clear polystyrene (MICROLON®) and additionally in black (FLUOTRAC™) and white (LUMITRAC™).

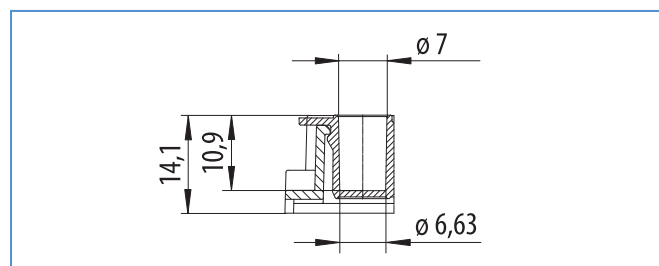

Figure 4:
Well profile: F-bottom
Total volume: 388 μ l
Working volume: 20 - 350 μ l

U8 and F8 Strip Plates



U8 and F8 Strip Plates

U8 clear

F8 clear / white / black







- Strips mounted in frame

762 070
762 071

767 07X

Free of detectable
DNase, RNase,
human DNA
non-pyrogenic

		
Cat.-No.	767 070	767 071
Description	strip plate	strip plate
Quantity x strip design	12 x U8 strips	12 x U8 strips
Well profile	U-bottom	U-bottom
Binding	MICROLON® 200 med. binding	MICROLON® 600 high binding
Colour of strips	clear	clear
Quantity per bag/case	5/100	5/100

						
Cat.-No.	762 070	762 071	762 075	762 074	762 076	762 077
Description	strip plate	strip plate	strip plate	strip plate	strip plate	strip plate
Quantity x strip design	12 x F8 strips	12 x F8 strips	12 x F8 strips	12 x F8 strips	12 x F8 strips	12 x F8 strips
Well profile	F-bottom	F-bottom	F-bottom	F-bottom	F-bottom	F-bottom
Binding	MICROLON® 200 med. binding	MICROLON® 600 high binding	LUMITRAC™ 200 med. binding	LUMITRAC™ 600 high binding	FLUOTRAC™ 200 med. binding	FLUOTRAC™ 600 high binding
Colour of strips	clear	clear	white	white	black	black
Quantity per bag/case	5/100	5/100	5/100	5/100	5/100	5/100

1 Cell/ Tissue Culture
2 HTS- Microplates
3 Immunology/ HLA
4 Microbiology/ Bacteriology
5 Tubes/Multi- Purpose Beakers
6 Liquid Handling
7 Molecular Biology
8 Protein Crystallisation
9 Separation
10 Biochips/ Microfluidics
11 Cryo-Techniques
12 Lids/Sealers/ CapMats
13 Reaction Tubes/ Analyser Cups
14 Accessories

F12, F16 and U16 Strip Plates

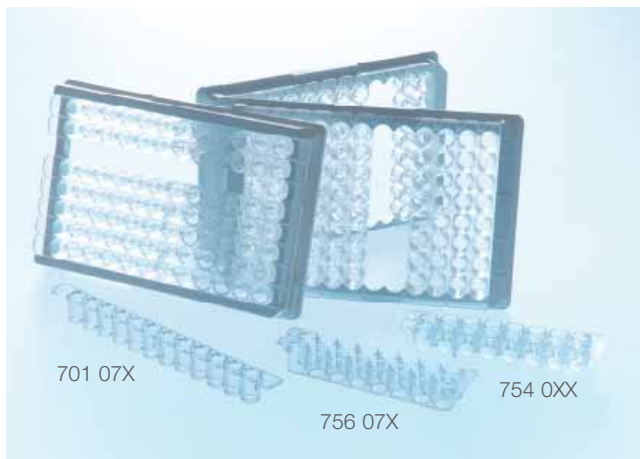

F12, F16 and U16 Strip Plates clear

- ↳ Clear F12 Strip Plates cell culture treated on request
 - ↳ Black and white F16 Strip Plates on request
 - ↳ Black and white U16 Strip Plates on request
- Strips mounted in frame

Free of detectable DNase, RNase, human DNA, non-pyrogenic

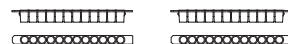

Cat.-No.	701 070	701 071
Description	strip plate	strip plate
Quantity x strip design	8 x F12 strips	8 x F12 strips
Well profile	F-bottom	F-bottom
Binding	MICROLON® 200 med. binding	MICROLON® 600 high binding
Colour of strips	clear	clear
Quantity per bag/case	5/100	5/100



Cat.-No.	756 070	756 071	754 070	754 061
Description	strip plate	strip plate	strip plate	strip plate
Quantity x strip design	6 x F16 strips	6 x F16 strips	6 x U16 strips	6 x U16 strips
Well profile	F-bottom	F-bottom	U-bottom	U-bottom
Binding	MICROLON® 200 med. binding	MICROLON® 600 high binding	MICROLON® 200 med. binding	MICROLON® 600 high binding
Colour of strips	clear	clear	clear	clear
Quantity per bag/case	5/100	5/100	5/100	5/100

Single-break Strip Plates

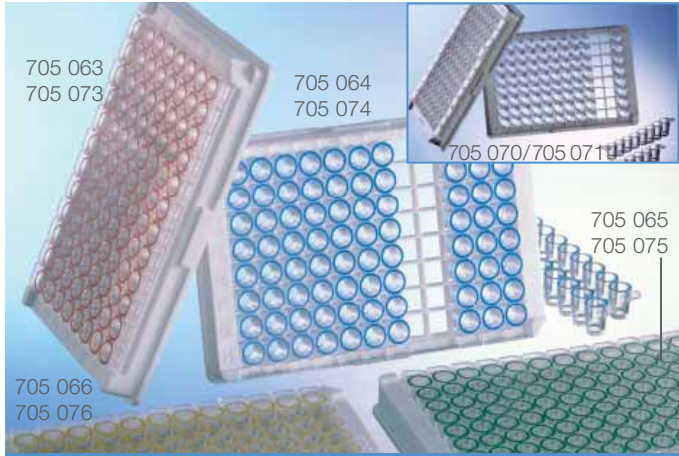

C8 Single-break Strip Plates Clear with / without Colour Coding

C8 Single-break Strip Plates without colour coding cell culture treated on request

- Strips mounted in frame

Free of detectable
DNase, RNase,
human DNA
non-pyrogenic



Cat.-No.	705 070	705 071	705 063	705 073	705 064	705 074
Description	SB strip plate	SB strip plate	SB strip plate	SB strip plate	SB strip plate	SB strip plate
Quantity x strip design	12 x C8 strips	12 x C8 strips	12 x C8 strips	12 x C8 strips	12 x C8 strips	12 x C8 strips
Well profile	C-bottom	C-bottom	C-bottom	C-bottom	C-bottom	C-bottom
Binding	MICROLON® 200 med. binding	MICROLON® 600 high binding	MICROLON® 200 med. binding	MICROLON® 600 high binding	MICROLON® 200 med. binding	MICROLON® 600 high binding
Colour of strips	clear	clear	clear	clear	clear	clear
Colour coding on the well rim	-	-	red	red	blue	blue
Quantity per bag/case	5/100	5/100	5/100	5/100	5/100	5/100

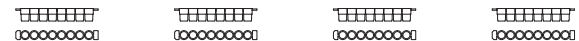

Cat.-No.	705 065	705 075	705 066	705 076
Description	SB strip plate	SB strip plate	SB strip plate	SB strip plate
Quantity x strip design	12 x C8 strips	12 x C8 strips	12 x C8 strips	12 x C8 strips
Well profile	C-bottom	C-bottom	C-bottom	C-bottom
Binding	MICROLON® 200 med. binding	MICROLON® 600 high binding	MICROLON® 200 med. binding	MICROLON® 600 high binding
Colour of strips	clear	clear	clear	clear
Colour coding on the well rim	green	green	yellow	yellow
Quantity per bag/case	5/100	5/100	5/100	5/100

Immuno Tubes

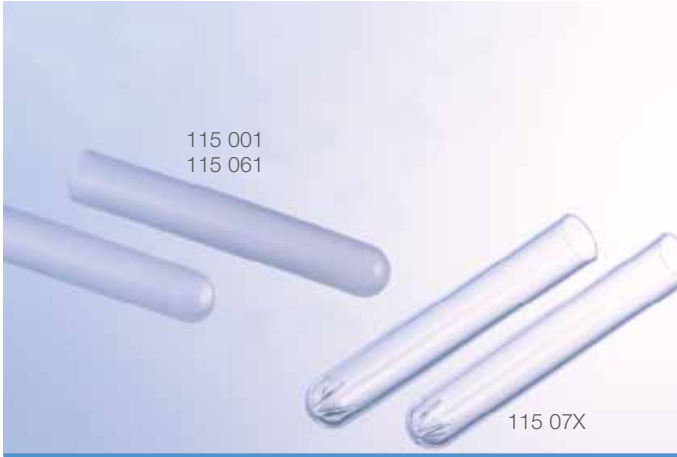

Immuno Tubes

- ▶ Tubes p. 5 | 3 ff.
- ▶ Cell Culture Tubes p. 1 | 21
- Manufactured from crystal clear polystyrene

Immuno tubes are often used for determining hormone levels, for example TSH (thyroid stimulating hormone). With a length of 75 mm and a diameter of 12 mm with and without a “star”, they are available in both MICROLON® 200 and MICROLON® 600 quality.

The so-called “star” at the bottom of the tubes serves to increase the surface and thus makes it possible to bind larger amounts of antigens or antibodies.

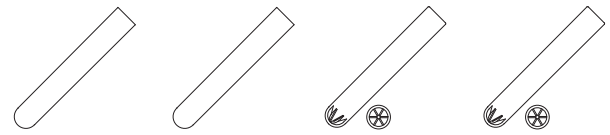

Cat.-No.	115 001	115 061	115 070	115 071
Bottom design	round	round	round with star	round with star
ø [mm] x height [mm]	12 x 75	12 x 75	12 x 75	12 x 75
Volume [ml]	5	5	5	5
Binding	MICROLON® 200 med. binding	MICROLON® 600 high binding	MICROLON® 200 med. binding	MICROLON® 600 high binding
Quantity per bag/case	250/2000	250/2000	250/2000	250/2000

Terasaki Plates

60 Well and 72 Well Terasaki Plates

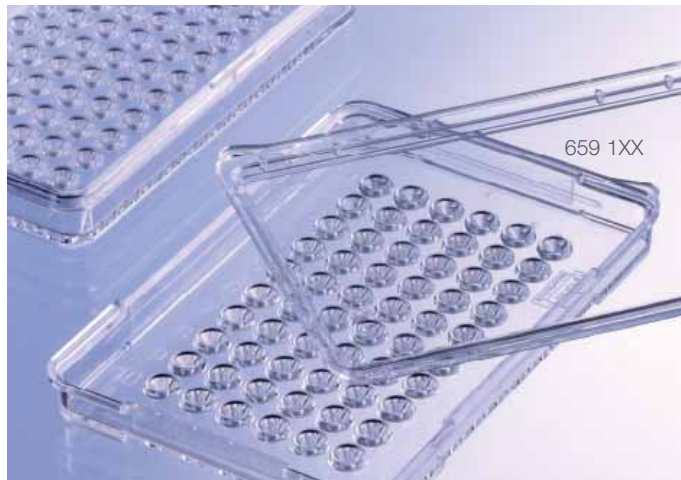

Terasaki Plates

- ▶ Microscopic coverslip for Terasaki plates
Cat.-No. 653 081
- ▶ Micro Dispenser for 60 well Terasaki plates
available on request
- Manufactured from crystal clear polystyrene

Terasaki Plates

The human leucocyte antigen (HLA) system is the major histocompatibility complex (MHC) of humans and is composed of the two polymorphic classes HLA-I (A, B, and C) and HLA-II (DR, DQ, and DP). Basically, four different areas of indication can be distinguished for HLA typing:

- Transplantation
- Transfusion
- Disease association
- Forensic

The serological determination of HLA proteins of the HLA-A, -B, -C and -DR genetic positions is primarily performed with the complement-dependent microlymphocytotoxicity test (LCT) or Terasaki test, which has been standardised since 1964. The basis for this test method is the cytolysis of the lymphocytes

to be tested, which is caused by the antibody-antigen mediated activation of the complement system. Permeabilised lymphocytes are generally stained with chromophores or fluorophores and evaluated microscopically.

Greiner Bio-One Terasaki plates are suitable for all applications for serological determination of HLA antigens. The plates are supplied either with 60 or 72 wells, the plate dimensions stay the same. The individual wells have a volume of 10 µl.

Cat.-No. 659 180 contains one lid per bag.

We provide Terasaki plates with 1 years' stability on the surface treatment.

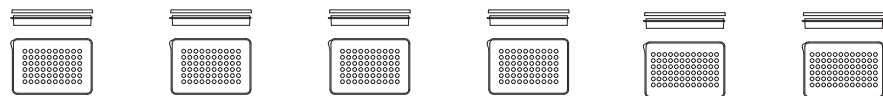

Cat.-No.	653 180	653 190	659 180	659 190	654 180	769 190
Well format	60 well	60 well	60 well	60 well	72 well	72 well
Working volume per well [µl]	10	10	10	10	10	10
Max. volume per well [µl]	11.5	11.5	11.5	11.5	11.5	11.5
Stackable	-	-	+	+	-	+
TC surface treatment	+	+	+	+	+	+
Lid	+	+	+	+	+	+
Quantity per bag/case	10/270	120 ^{*)} /480	10/200	150 ^{*)} /1200	10/270	150 ^{*)} /1200

^{*)} folding carton

^{*)} folding carton

^{*)} folding carton